

Peplink Balance Multi-WAN Routers

Model 20/30/210/310/380/390/580/710/1350

User Manual

Firmware 5.1

September 10



Copyright & Trademarks Specifications are subject to change without prior notice. Copyright © 2010 Peplink International Ltd. All Rights Reserved. Peplink and the Peplink logo are trademarks of Peplink International Ltd. Other brands or products mentioned may be trademarks or registered trademarks of their respective owners.

Table of Contents

1	INTRODUCTION AND SCOPE	5
2	GLOSSARY	6
3	PRODUCT FEATURES.....	7
3.1	Supported Network Features.....	7
3.2	Other Supported Features.....	8
4	PACKAGE CONTENTS	9
5	PEPLINK BALANCE OVERVIEW	10
5.1	Peplink Balance 20.....	10
5.2	Peplink Balance 30.....	12
5.3	Peplink Balance 210.....	14
5.4	Peplink Balance 310.....	16
5.5	Peplink Balance 380 / 390.....	18
5.6	Peplink Balance 580.....	21
5.7	Peplink Balance 710.....	24
5.8	Peplink Balance 1350.....	27
6	INSTALLATION.....	30
6.1	Preparation	30
6.2	Constructing the Network	30
6.3	Configuring the Network Environment.....	31
7	BASIC CONFIGURATION.....	32
7.1	Connecting to Web Admin Interface.....	32
7.2	Configuration with Setup Wizard	33
7.3	Advanced Setup	36
8	CONFIGURATION OF LAN INTERFACE.....	37
9	DROP-IN MODE.....	41
10	CONFIGURATION OF WAN INTERFACE(S).....	44
10.1	Connection Method(s).....	44
10.2	WAN Health Check	55
10.3	Bandwidth Allowance Monitor.....	58
10.4	Additional Public IP Settings	59
10.5	Dynamic DNS Settings	60
11	SITE-TO-SITE VPN	61
11.1	Site-to-Site VPN Settings.....	61
11.2	Peplink Balance Behind NAT Router	64
11.3	VPN Status.....	65
12	MANAGEMENT OF OUTBOUND TRAFFIC TO WAN.....	66
12.1	Outbound Policy.....	67
12.2	Custom Rules For Outbound Policy.....	68

13	INBOUND ACCESS.....	73
13.1	Definition of Port Forwarding	73
13.2	Definition of Servers on LAN.....	75
13.3	Inbound Access Services.....	76
13.4	UPnP / NAT-PMP Settings	78
13.5	Definition of DNS Records	79
14	NAT MAPPINGS.....	89
15	QOS	90
15.1	User Groups	90
15.2	Bandwidth Control.....	90
15.3	Application.....	92
16	FIREWALL.....	94
16.1	Outbound and Inbound Firewall.....	94
16.2	Intrusion Detection and DoS Prevention.....	98
17	MISCELLANEOUS SETTINGS	99
17.1	High Availability.....	99
17.2	PPTP Server	102
17.3	Service Forwarding	103
17.4	Service Passthrough.....	105
18	SYSTEM SETTINGS	106
18.1	Admin Security.....	106
18.2	Firmware Upgrade	109
18.3	Time	110
18.4	Email Notification	111
18.5	Remote Syslog.....	113
18.6	SNMP	114
18.7	Reporting Server.....	116
18.8	Configuration.....	118
18.9	Flash Management	119
18.10	Reboot.....	120
18.11	Ping Test.....	121
18.12	Traceroute Test.....	122
19	STATUS	123
19.1	Device	123
19.2	Active Sessions.....	124
19.3	Client List	124
19.4	WINS Client.....	125
19.5	Site-to-Site VPN	125
19.6	UPnP / NAT-PMP.....	126
19.7	Event Log	126
19.8	Bandwidth	127

APPENDIX A. RESTORATION OF FACTORY DEFAULTS	130
APPENDIX B. ROUTING UNDER DHCP, STATIC IP, AND PPPOE.....	131
B.1 Routing via Network Address Translation (NAT).....	132
B.2 Routing via IP Forwarding	133
APPENDIX C. CASE STUDIES	134
C.1 Performance Optimization	134
C.2 Maintaining the Same IP Address throughout a Session.....	136
C.3 Bypassing the Firewall to Access Hosts on LAN.....	137
C.4 Inbound Access Restriction	138
C.5 Outbound Access Restriction	139
APPENDIX D. TROUBLESHOOTING.....	140
APPENDIX E. PRODUCT SPECIFICATIONS.....	142
E.1 Peplink Balance 20 and 30.....	142
E.2 Peplink Balance 210 and 310.....	143
E.3 Peplink Balance 380 and 390.....	144
E.4 Peplink Balance 580.....	145
E.5 Peplink Balance 710.....	146
E.6 Peplink Balance 1350.....	147

1 Introduction and Scope

The Peplink Balance series provides link aggregation and load balancing across up to thirteen WAN connections.

The Peplink Balance 20/30 provides a cost-effective solution suitable for power users and home offices.

The Peplink Balance 210/310 provides advanced features for small business.

The Peplink Balance 380, 390, 580, 710 and 1350, with a suite of advanced enterprise-class features, make ideal single-box solutions for medium to large-sized business environments, and allow service providers to enable highly available multi-network services.

This manual applies to the following Peplink Balance products:

- Peplink Balance 20/30 (firmware version v5.1.x)
- Peplink Balance 210/310 (firmware version v5.1.x)
- Peplink Balance 380/390 (firmware version v5.1.x)
- Peplink Balance 580 (firmware version v5.1.x)
- Peplink Balance 710 (firmware version v5.1.x)
- Peplink Balance 1350 (firmware version v5.1.x)

The manual presents how-to set up Peplink Balance, and provides a collection of case studies involving advanced features of Peplink Balance.

Important Note to Users Upgrading from Firmware 4.7 or below

If your current firmware version is 4.7 or below, please upgrade to 4.8.2 first before upgrading to 5.1.

Important Note to Users of Peplink Balance 30 (Classic Edition)

Firmware 5.0 or above is NOT applicable to Peplink Balance 30 (Classic Edition). For information related to the difference between generations of Peplink Balance 30, please visit our knowledge base at <<http://www.peplink.com/index.php?view=faq&id=231&path=16>>.

2 Glossary

The following terms, acronyms, and abbreviations are frequently used in this manual:

Term	Definition
3G	3rd Generation family of standards for wireless communications
DHCP	Dynamic Host Configuration Protocol
DNS	Domain Name System
EVDO	Evolution-Data Optimized
HSDPA	High-Speed Downlink Packet Access
GRE	Generic Routing Encapsulation
HTTP	Hyper-Text Transfer Protocol
ICMP	Internet Control Message Protocol
IP	Internet Protocol
LAN	Local Area Network
MAC Address	Media Access Control Address
MTU	Maximum Transmission Unit
MSS	Maximum Segment Size
NAT	Network Address Translation
PPPoE	Point to Point Protocol over Ethernet
QoS	Quality of Service
SNMP	Simple Network Management Protocol
TCP	Transmission Control Protocol
UDP	User Datagram Protocol
VPN	Virtual Private Network
VRRP	Virtual Router Redundancy Protocol
WAN	Wide Area Network
WINS	Windows Internet Name Service

3 Product Features

Peplink Balance Series products enable all LAN users to share broadband Internet connections, and provide advanced features to enhance Internet access. The following is the list of supported features:

3.1 Supported Network Features

3.1.1 WAN

- Multiple public IP support (DHCP, PPPoE, Static IP Address, or GRE)
- 10/100 Mbps Connection in Full/Half Duplex
- 1000 Mbps Connection in Full/Half Duplex (**Available only with Peplink Balance 390, 580, 710 and 1350**)
- USB Mobile Connection* (**Available only with Peplink Balance 20, 30, 380, 390, 580, 710 and 1350**) *Remark: Only one USB modem can be connected.
- Drop-in Mode on selectable WAN port with MAC address passthrough (**Available only with Peplink Balance 210, 310, 380, 390, 580, 710 and 1350**)
- Network Address Translation (NAT) / Port Address Translation (PAT)
- Inbound and Outbound NAT mapping
- IPsec NAT-T and PPTP packet passthrough
- Multiple static IP addresses per WAN Connection
- MAC address clone
- Customizable MTU and MSS values
- WAN connection health check
- Dynamic DNS (Supported service providers: changeip.com, dyndns.org, no-ip.org and tzo.com)

3.1.2 LAN

- DHCP server on LAN
- Static routing rules
- Local DNS

3.1.3 VPN

(Available only with Peplink Balance 210, 310, 380, 390, 580, 710 and 1350)

- Secure Site-to-Site VPN
- VPN load balancing and failover among selected WAN connections
- Site-to-Site VPN bandwidth bonding
- Ability to route Internet traffic to a remote VPN peer
- PPTP server
- PPTP and IPsec passthrough

3.1.4 Firewall

- Outbound (LAN to WAN) firewall rules
- Inbound (WAN to LAN) firewall rules per WAN connection
- Intrusion detection and prevention
- Specification of NAT mappings

3.1.5 Inbound Traffic Management

- TCP/UDP traffic redirection to dedicated LAN server(s)
- Inbound link load balancing by means of DNS (**Available only with Peplink Balance 210, 310, 380, 390, 580, 710 and 1350**)

3.1.6 Outbound Policy

- Link load distribution per TCP/UDP service
- Persistent routing for specified source and/or destination IP addresses per TCP/UDP service

3.1.7 QoS

(Available only with Peplink Balance 210, 310, 380, 390, 580, 710 and 1350)

- Quality of Service for different applications and custom protocols
- User Group classification for different service levels (**Available only with Peplink Balance 380, 390, 580, 710 and 1350**)
- Bandwidth usage control and monitoring on group- and user- level (**Available only with Peplink Balance 380, 390, 580, 710 and 1350**)
- Application Prioritization for custom protocols and DSL optimization

3.2 Other Supported Features

- Easy-to-use web-based administration interface
- HTTP and HTTPS support for Web Administration Interface
- Configurable web administration port and administrator password
- Firmware upgrades, configuration backups, Ping, and Traceroute via Web Administration Interface
- Remote web based configuration (via WAN and LAN interfaces)
- Remote reporting to Peplink Balance reporting server
- Hardware High Availability via VRRP, with automatic configuration synchronization (**Available only with Balance 210, 310, 380, 390, 580, 710 and 1350**)
- Hardware backup via LAN bypass (**Available only with Balance 390 (Hardware version 2), Balance 580 and 1350**)
- Read-only user for Web Admin
- Built-in WINS server
- Time server synchronization
- SNMP
- Email notification
- Syslog
- SIP passthrough
- PPTP packet passthrough
- Event Log
- Active Sessions
- Client List
- WINS Client List
- UPnP / NAT-PMP

4 Package Contents

The contents of Peplink Balance product packages are as follows:

4.1 Peplink Balance 20 / 30

- Peplink Balance 20 / 30
- Power adapter
- Information slip

4.2 Peplink Balance 210 / 310

- Peplink Balance 210 / 310
- Power adapter
- Information slip
- Rackmount kit

4.3 Peplink Balance 380 / 390 / 580 / 710 / 1350

- Peplink Balance 380/390/580/710/1350
- Power cord
- Information slip
- Rackmount kit

5 Peplink Balance Overview

5.1 Peplink Balance 20

5.1.1 Front Panel Appearance

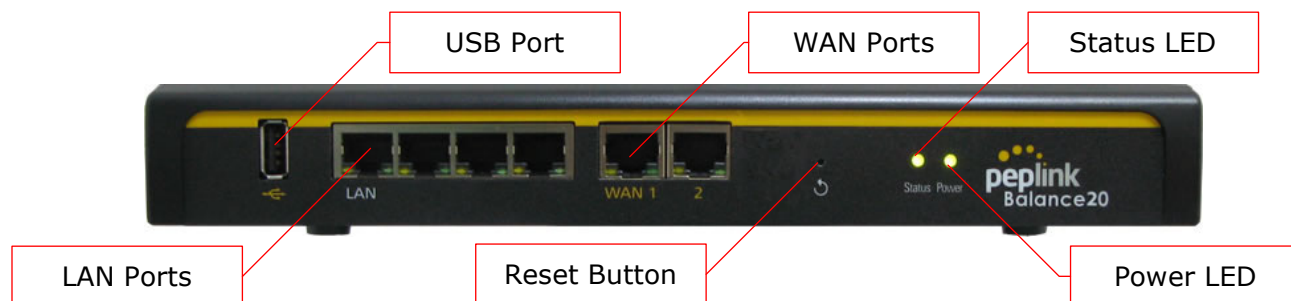

5.1.2 LED Indicators

The statuses indicated by the Front Panel LEDs are as follows:

Power and Status Indicators	
Power	OFF – Power off
	Green – Power on
Status	OFF – System initializing
	Red – Booting up or busy
	Green – Ready state

LAN and WAN Ports	
Green LED	ON – 100 Mbps
	OFF – 10 Mbps
Yellow LED	Solid – Port is connected without traffic
	Blinking – Data is transferring
	OFF – Port is not connected
Port Type	Auto MDI/MDI-X ports

USB Port	
USB Ports	For connecting a USB based mobile modem.

5.1.3 Rear Panel Appearance

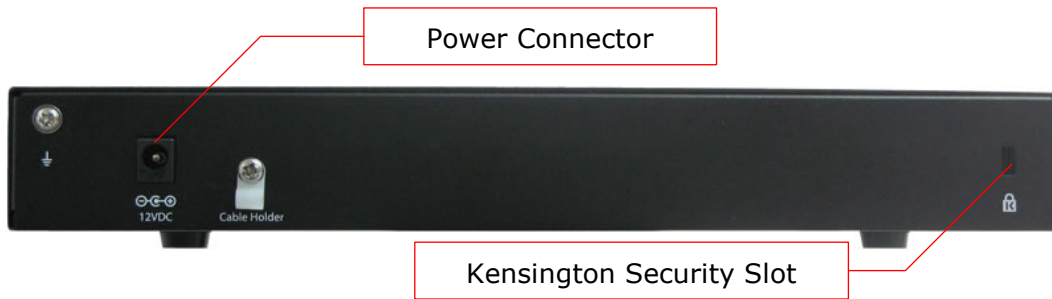

5.1.4 Unit Base Appearance

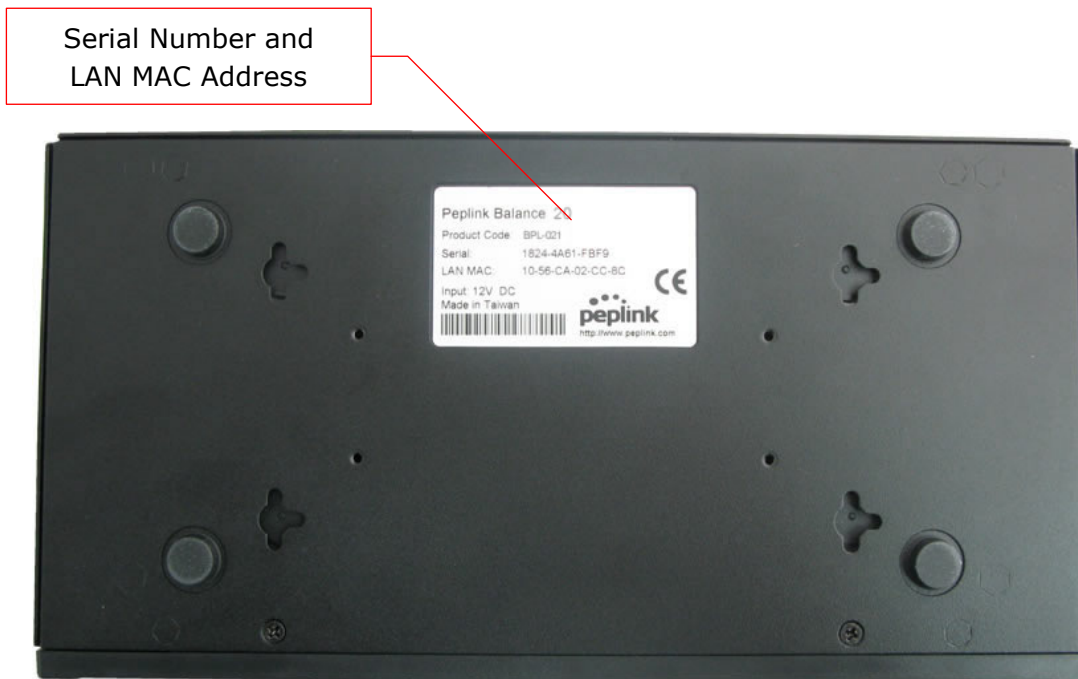

5.2 Peplink Balance 30

5.2.1 Front Panel Appearance

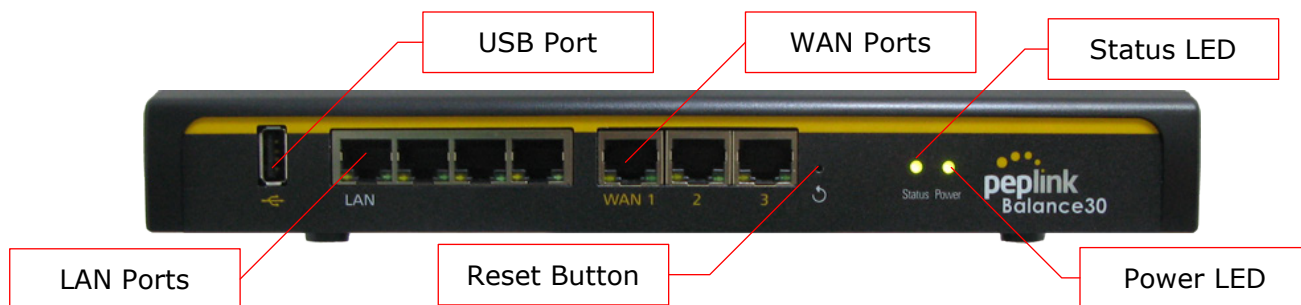

5.2.2 LED Indicators

The statuses indicated by the Front Panel LEDs are as follows:

Power and Status Indicators	
Power	OFF – Power off
	Green – Power on
Status	OFF – System initializing
	Red – Booting up or busy
	Green – Ready state

LAN and WAN Ports	
Green LED	ON – 100 Mbps
	OFF – 10 Mbps
Yellow LED	Solid – Port is connected without traffic
	Blinking – Data is transferring
	OFF – Port is not connected
Port Type	Auto MDI/MDI-X ports

USB Port	
USB Ports	For connecting a USB based mobile modem.

5.2.3 Rear Panel Appearance

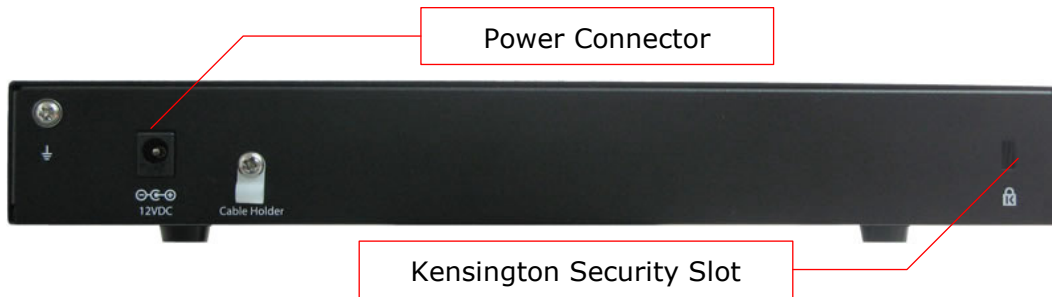

5.2.4 Unit Base Appearance



5.3 Peplink Balance 210

5.3.1 Front Panel Appearance

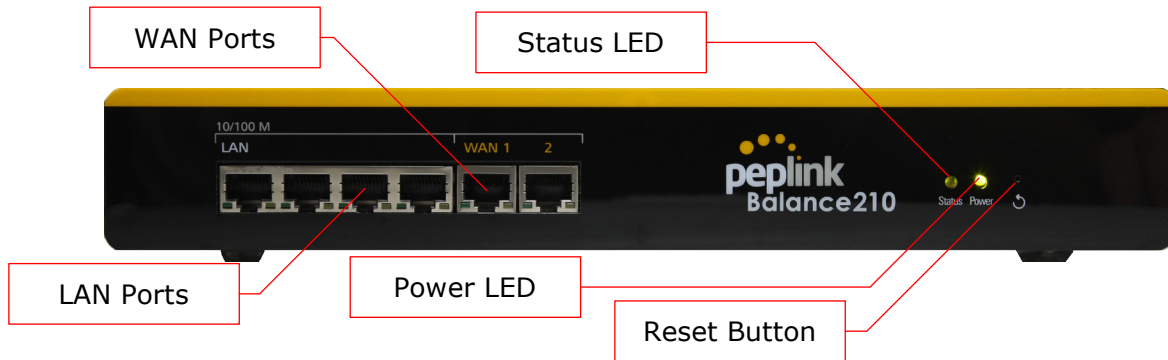

5.3.2 LED Indicators

The statuses indicated by the Front Panel LEDs are as follows:

Power and Status Indicators	
Power	OFF – Power off
	Green – Power on
Status	OFF – System initializing
	Red – Booting up or busy
	Green – Ready state

LAN and WAN Ports	
Green LED	ON – 100 Mbps
	OFF – 10 Mbps
Yellow LED	Solid – Port is connected without traffic
	Blinking – Data is transferring
	OFF – Port is not connected
Port Type	Auto MDI/MDI-X ports

5.3.3 Rear Panel Appearance

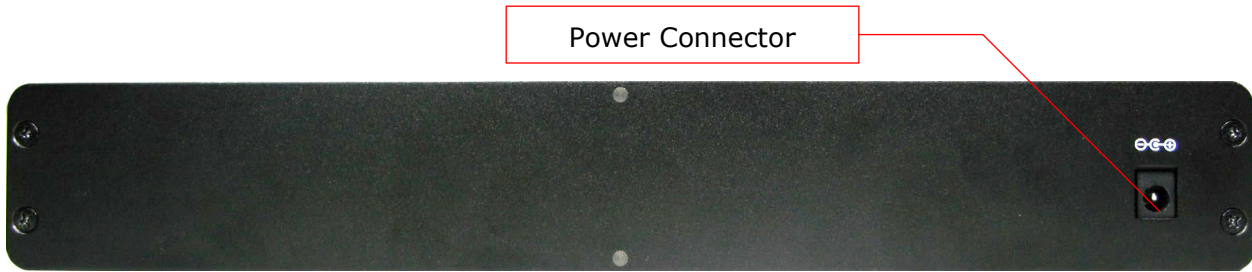

Power Connector

5.3.4 Unit Base Appearance



Serial Number and
LAN MAC Address

5.4 Peplink Balance 310

5.4.1 Front Panel Appearance

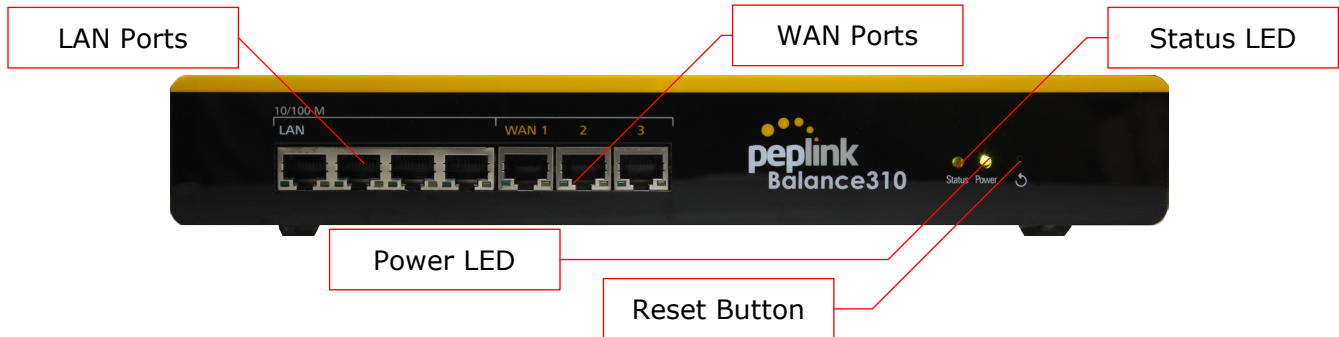

5.4.2 LED Indicators

The statuses indicated by the Front Panel LEDs are as follows:

Power and Status Indicators	
Power	OFF – Power off
	Green – Power on
Status	OFF – System initializing
	Red – Booting up or busy
	Green – Ready state

LAN and WAN Ports	
Green LED	ON – 100 Mbps
	OFF – 10 Mbps
Yellow LED	Solid – Port is connected without traffic
	Blinking – Data is transferring
	OFF – Port is not connected
Port Type	Auto MDI/MDI-X ports

5.4.3 Rear Panel Appearance

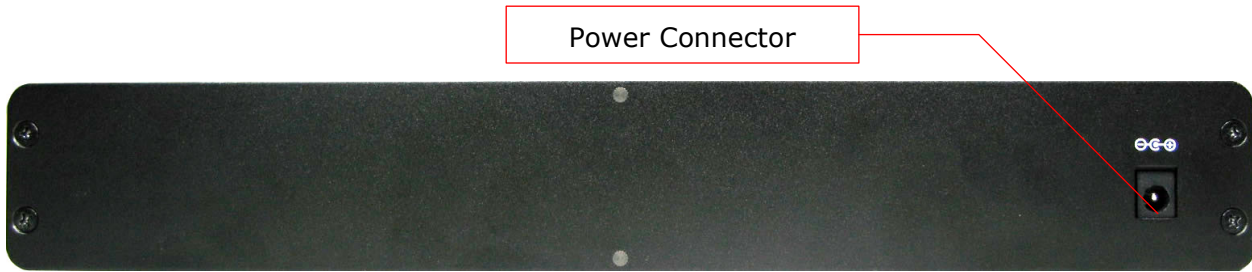

5.4.4 Unit Base Appearance



5.5 Peplink Balance 380 / 390

5.5.1 Front Panel Appearance

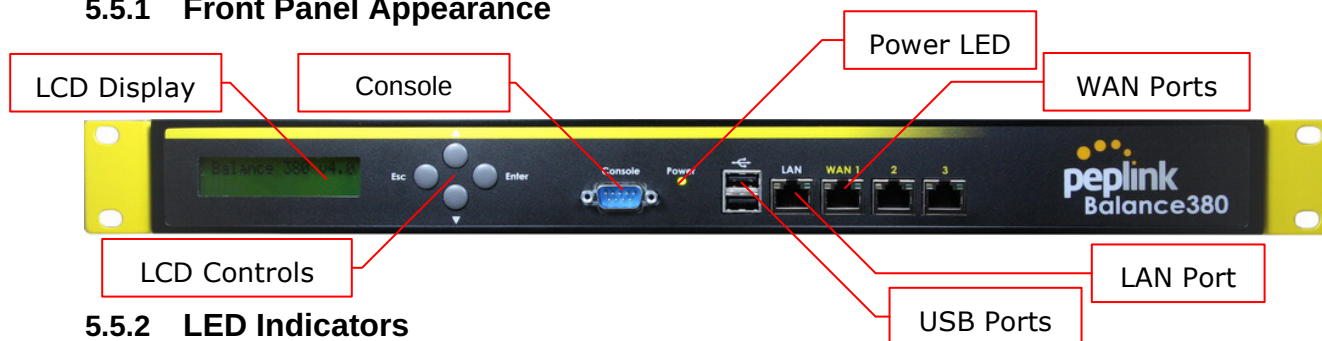

5.5.2 LED Indicators

The statuses indicated by the Front Panel LEDs are as follows:

Power and Status Indicators	
Power LED	OFF – Power off
	Green – Power on

Console and USB Ports	
Console Port	Reserved for engineering Use
USB Ports	For connecting a USB based mobile modem.

LAN and WAN Ports (Balance 380)	
Green LED	ON – 100 Mbps
	OFF – 10 Mbps
Yellow LED	Solid – Port is connected without traffic
	Blinking – Data is transferring
	OFF – Port is not connected
Port Type	MDI ports

LAN Port and WAN Ports (Gigabit ports on Balance 390)	
Green LED	ON – 1000 Mbps
	OFF – 100/10 Mbps
Yellow LED	Solid – Port is connected without traffic
	Blinking – Data is transferring
	OFF – Port is not connected
Port Type	Auto MDI/MDI-X ports

5.5.3 LCD Display Menu

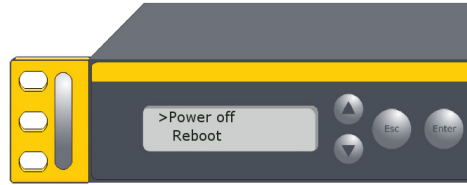

- > HA State:Master/Slave
 - > LAN IP
 - > VIP
- > System Status
 - > System
 - > Firmware ver. (shows firmware version)
 - > Serial number (shows serial number)
 - > System time (shows current time)
 - > System up time (shows system uptime since last reboot)
 - > CPU load (shows current CPU loading, 0-100%)
 - > LAN
 - > Status (shows LAN port physical status)
 - > IP address (shows LAN IP address)
 - > Subnet mask (shows LAN subnet mask)
 - > Link status (shows Connected/Disconnected, IP address list)
 - > WAN1
 - > WAN2
 - > WAN3
 - > VPN status (shows Connected/Disconnected)
 - > VPN Profile 1
 - > VPN Profile 2
 - > ...
 - > VPN Profile n
 - > Link usage
 - > Throughput in (shows transfer rate in Kbps)
 - > WAN1
 - > WAN2
 - > WAN3
 - > Throughput out (shows transfer rate in Kbps)
 - > WAN1
 - > WAN2
 - > WAN3
 - > Data Transfer'd (shows volume transferred since last reboot in MB)
 - > WAN1
 - > WAN2
 - > WAN3
- > Maintenance
 - > Reboot > Reboot? (Yes/No) (to reboot the unit)
 - > Factory default > Factory default? (Yes/No) (to restore factory defaults)
- > LAN config
 - > Port speed (shows port speed: Auto, 10baseT-FD, 10baseT-HD, 100baseTx-FD, 100baseTx-HD)
NOTE: Balance 390 also has 1000baseTx-FD.
 - > LAN
 - > WAN1
 - > WAN2
 - > WAN3

5.5.4 Rear Panel Appearance

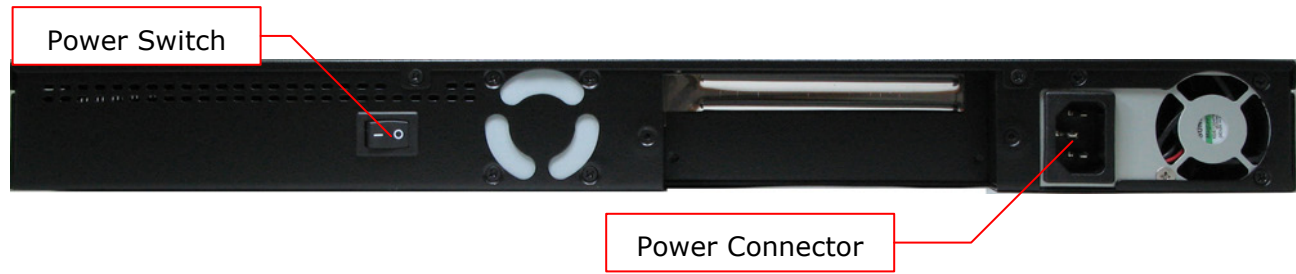

Connector Ports	
Power Connector	AC input 110/220V



Switch	
Power Switch	To hold pressing the key for 4 seconds will power down the unit When the unit is powered off, press it will power on the unit

5.5.5 Unit Label Appearance

Serial Number and LAN MAC Address

Peplink Balance 380
 Product Code: BPL-380
 Serial: 1234-5678-9000
 LAN MAC: xx-xx-xx-yy-yy-yy

Made in Taiwan





<http://www.peplink.com>

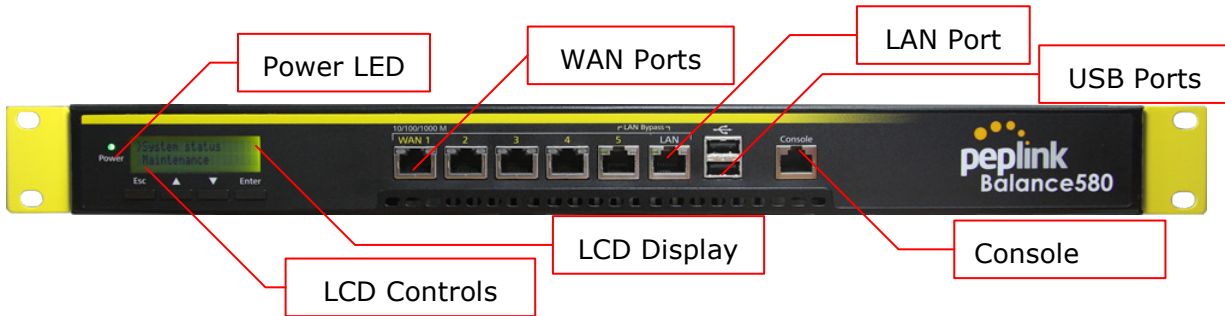

5.6 Peplink Balance 580

5.6.1 Front Panel Appearance



5.6.2 LED Indicators

The statuses indicated by the Front Panel LEDs are as follows:

Power and Status Indicators	
Power LED	OFF – Power off
	Green – Power on

Console and USB Ports	
Console Port	Reserved for engineering Use
USB Ports	For connecting a USB based mobile modem.

LAN Port and WAN Ports	
Green LED	ON – 1000 Mbps
	OFF – 100/10 Mbps
Yellow LED	Solid – Port is connected without traffic
	Blinking – Data is transferring
	OFF – Port is not connected
Port Type	Auto MDI/MDI-X ports

5.6.3 LCD Display Menu

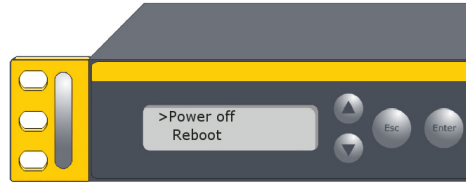

- > HA State:Master/Slave
 - > LAN IP
 - > VIP
- > System Status
 - > System
 - > Firmware ver. (shows firmware version)
 - > Serial number (shows serial number)
 - > System time (shows current time)
 - > System up time (shows system uptime since last reboot)
 - > CPU load (shows current CPU loading, 0-100%)
 - > LAN
 - > Status (shows LAN port physical status)
 - > IP address (shows LAN IP address)
 - > Subnet mask (shows LAN subnet mask)
 - > Link status (shows Connected/Disconnected, IP address list)
 - > WAN1
 - > WAN2
 - > ...
 - > WAN5
 - > VPN status (shows Connected/Disconnected)
 - > VPN Profile 1
 - > VPN Profile 2
 - > ...
 - > VPN Profile n
 - > Link usage
 - > Throughput in (shows transfer rate in Kbps)
 - > WAN1
 - > WAN2
 - > ...
 - > WAN5
 - > Throughput out (shows transfer rate in Kbps)
 - > WAN1
 - > WAN2
 - > ...
 - > WAN5
 - > Data Transfer'd (shows volume transferred since last reboot in MB)
 - > WAN1
 - > WAN2
 - > ...
 - > WAN5
- > Maintenance
 - > Reboot (to reboot the unit)
 - > Factory default > Factory default? (Yes/No) (to restore factory defaults)
- > LAN config
 - > Port speed (shows port speed: Auto, 10baseT-FD, 10baseT-HD, 100baseTx-FD, 100baseTx-HD)
 - > LAN
 - > WAN1
 - > WAN2
 - > ...
 - > WAN5

NOTE: Balance 390 also has 1000baseTx-FD.

5.6.4 Rear Panel Appearance

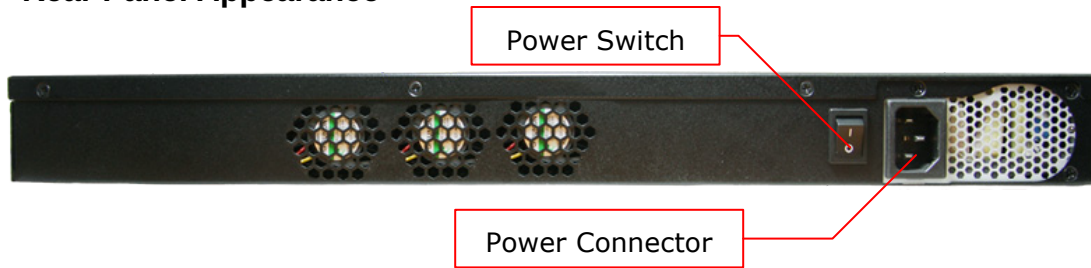

Connector Ports	
Power Connector	AC input 110/220V

Switch	
Power Switch	To hold pressing the key for 4 seconds will power down the unit When the unit is powered off, press it will power on the unit

5.6.5 Unit Label Appearance

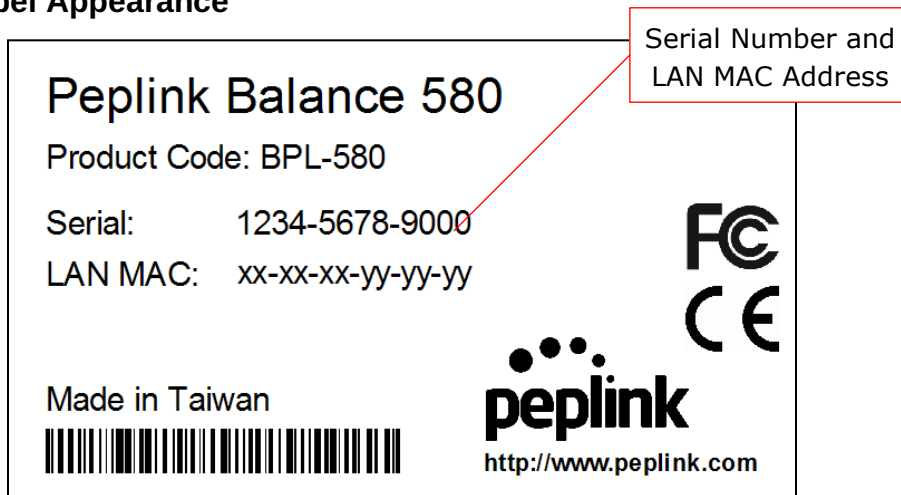

5.7 Peplink Balance 710

5.7.1 Front Panel Appearance

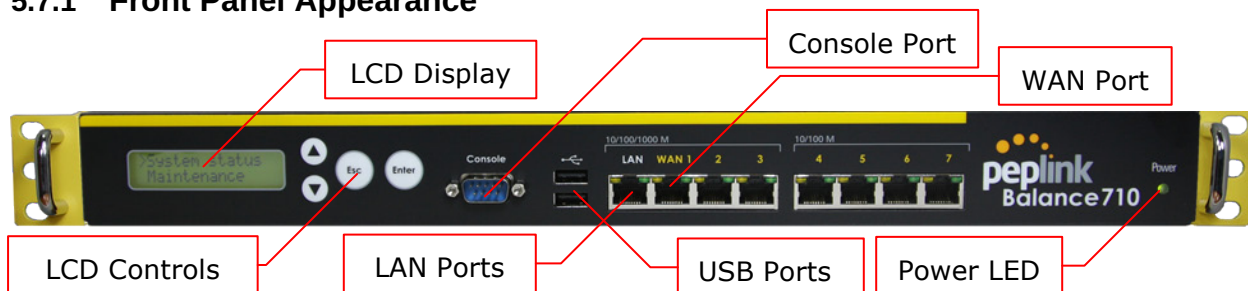

Status indicated in the Front Panel is as follows:

LED Indicator	
Power LED	OFF – Power off
	ON (Green) – Power on

Console & USB Ports	
Console Port	Reserved for engineering Use
USB Ports	For connecting a USB based mobile modem.

LAN Port and WAN Ports 1 to 3 (Gigabit Ethernet)	
Green LED	ON – 1000 Mbps
	OFF – 100/10 Mbps
Yellow LED	Solid – Port is connected without traffic
	Blinking – Data is transferring
	OFF – Port is not connected
Port Type	Auto MDI/MDI-X ports

WAN Ports 4 to 7 (Fast Ethernet)	
Green LED	ON – 100 Mbps
	OFF – 10 Mbps
Yellow LED	Solid – Port is connected without traffic
	Blinking – Data is transferring
	OFF – Port is not connected
Port Type	MDI ports

5.7.2 LCD Display Menu

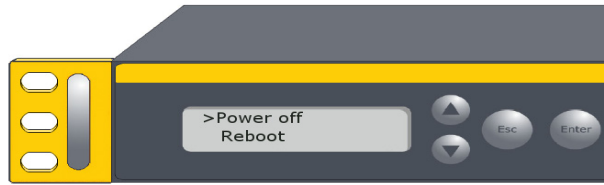

- > HA State:Master/Slave
 - > LAN IP
 - > VIP
- > System Status
 - > System
 - > Firmware ver. (shows firmware version)
 - > Serial number (shows serial number)
 - > System time (shows current time)
 - > System up time (shows system uptime since last reboot)
 - > CPU load (shows current CPU loading, 0-100%)
 - > LAN
 - > Status (shows LAN port physical status)
 - > IP address (shows LAN IP address)
 - > Subnet mask (shows LAN subnet mask)
 - > Link status (shows Connected/Disconnected, IP address list)
 - > WAN1
 - > WAN2
 - > ...
 - > WAN7
 - > VPN status (shows Connected/Disconnected)
 - > VPN Profile 1
 - > VPN Profile 2
 - > ...
 - > VPN Profile n
 - > Link usage
 - > Throughput in (shows transfer rate in Kbps)
 - > WAN1
 - > WAN2
 - > ...
 - > WAN7
 - > Throughput out (shows transfer rate in Kbps)
 - > WAN1
 - > WAN2
 - > ...
 - > WAN7
 - > Data Transfer'd (shows volume transferred since last reboot in MB)
 - > WAN1
 - > WAN2
 - > ...
 - > WAN7
- > Maintenance
 - > Reboot > Reboot? (Yes/No) (to reboot the unit)
 - > Factory default > Factory default? (Yes/No) (to restore factory defaults)
- > LAN config
 - > Port speed (shows port speed: Auto, 10baseT-FD, 10baseT-HD, 100baseTx-FD, 100baseTx-HD, 1000baseTx-FD)
 - > LAN
 - > WAN1
 - > WAN2
 - > ...
 - > WAN7

5.7.3 Rear Panel Appearance

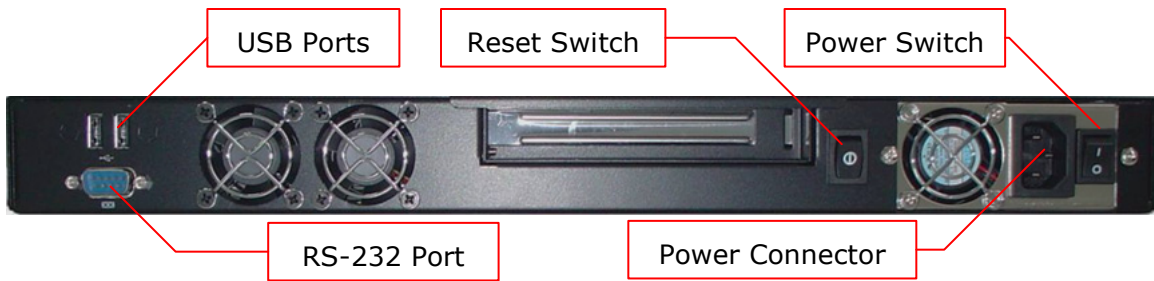

Connector Ports	
RS-232 Port	Reserved for engineering use
USB Ports	For connecting a USB based mobile modem.
Power Connector	AC input 110/220V

Switches	
Power Switch	To hold pressing the key for 4 seconds will power down the unit When the unit is powered off, press it will power on the unit
Reset Switch	Press and release once to reset the system

5.7.4 Unit Label Appearance

Serial Number and
LAN MAC Address

Peplink Balance 710





Product Code: BPL-710

Serial: 1234-5678-9000

LAN MAC: xx-xx-xx-yy-yy-yy

Made in Taiwan





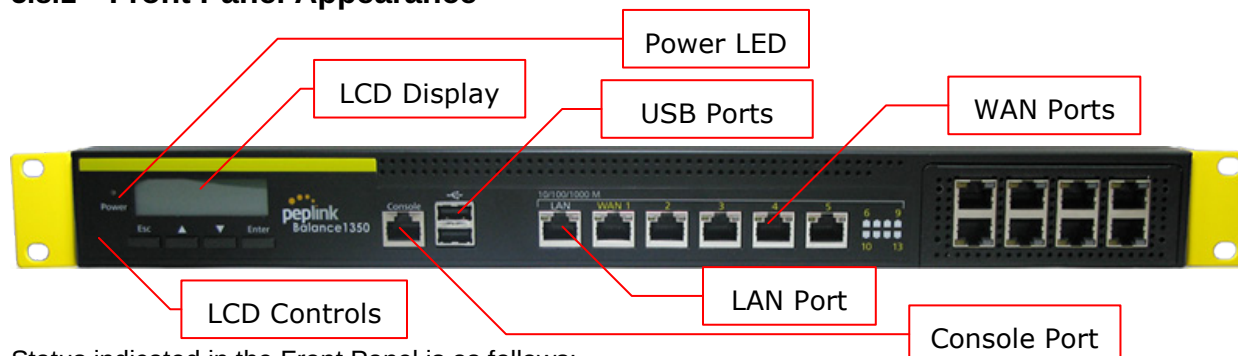

<http://www.peplink.com>

5.8 Peplink Balance 1350

5.8.1 Front Panel Appearance



Status indicated in the Front Panel is as follows:

LED Indicator	
Power LED	OFF – Power off ON (Green) – Power on

Console & USB Ports	
Console Port	Reserved for engineering Use
USB Ports	For connecting a USB based mobile modem.

LAN Port and WAN Ports 1 to 3 (Gigabit Ethernet)	
Green LED	ON – 1000 Mbps OFF – 100/10 Mbps
Yellow LED	Solid – Port is connected without traffic Blinking – Data is transferring OFF – Port is not connected
Port Type	Auto MDI/MDI-X ports

WAN Ports 4 to 7 (Fast Ethernet)	
Green LED	ON – 100 Mbps OFF – 10 Mbps
Yellow LED	Solid – Port is connected without traffic Blinking – Data is transferring OFF – Port is not connected
Port Type	MDI ports

5.8.2 LCD Display Menu

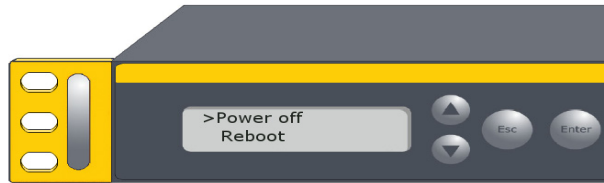

- > HA State:Master/Slave
 - > LAN IP
 - > VIP
- > System Status
 - > System
 - > Firmware ver. (shows firmware version)
 - > Serial number (shows serial number)
 - > System time (shows current time)
 - > System up time (shows system uptime since last reboot)
 - > CPU load (shows current CPU loading, 0-100%)
 - > LAN
 - > Status (shows LAN port physical status)
 - > IP address (shows LAN IP address)
 - > Subnet mask (shows LAN subnet mask)
 - > Link status (shows Connected/Disconnected, IP address list)
 - > WAN1
 - > WAN2
 - > ...
 - > WAN7
 - > VPN status (shows Connected/Disconnected)
 - > VPN Profile 1
 - > VPN Profile 2
 - > ...
 - > VPN Profile n
 - > Link usage
 - > Throughput in (shows transfer rate in Kbps)
 - > WAN1
 - > WAN2
 - > ...
 - > WAN7
 - > Throughput out (shows transfer rate in Kbps)
 - > WAN1
 - > WAN2
 - > ...
 - > WAN7
 - > Data Transfer'd (shows volume transferred since last reboot in MB)
 - > WAN1
 - > WAN2
 - > ...
 - > WAN7
- > Maintenance
 - > Reboot (to reboot the unit)
 - > Factory default > Reboot? (Yes/No) (to restore factory defaults)
 - > Factory default? (Yes/No)
- > LAN config
 - > Port speed (shows port speed: Auto, 10baseT-FD, 10baseT-HD, 100baseTx-FD, 100baseTx-HD, 1000baseTx-FD)
 - > LAN
 - > WAN1
 - > WAN2
 - > ...
 - > WAN7

5.8.3 Rear Panel Appearance

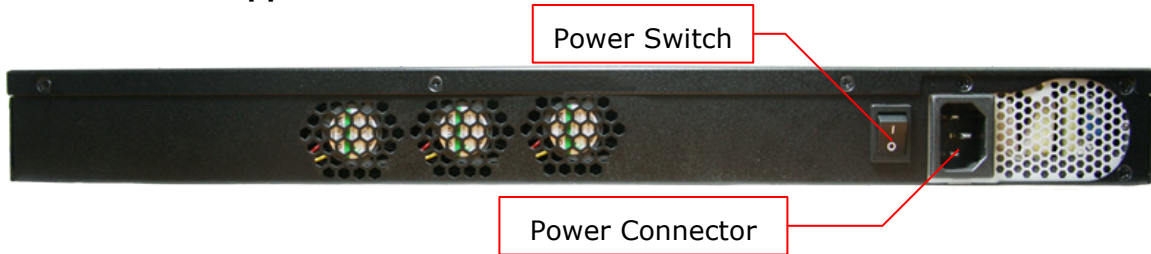

Connector Ports	
RS-232 Port	Reserved for engineering use
USB Ports	For connecting a USB based mobile modem.
Power Connector	AC input 110/220V

Switches	
Power Switch	To hold pressing the key for 4 seconds will power down the unit When the unit is powered off, press it will power on the unit
Reset Switch	Press and release once to reset the system

5.8.4 Unit Label Appearance

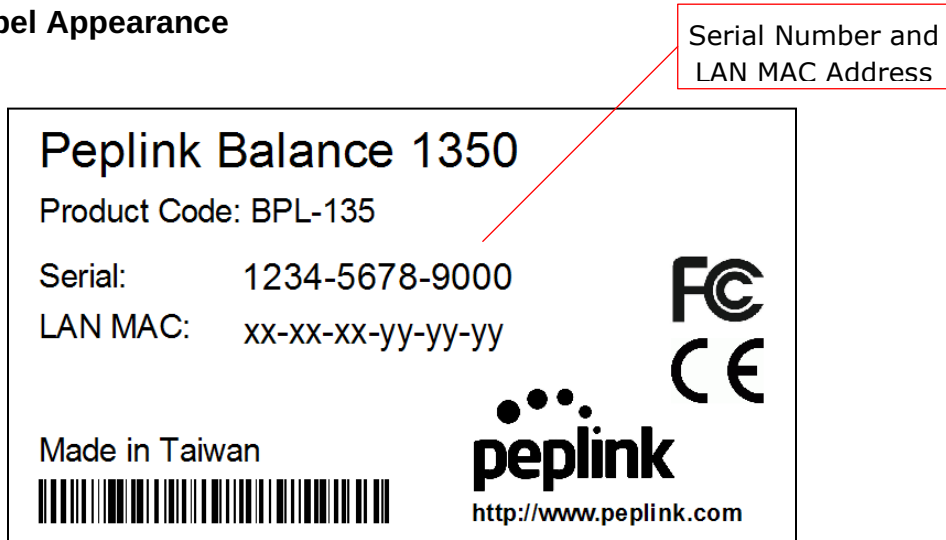

6 Installation

Connecting the Network with Peplink Balance:

6.1 Preparation

Before installing Peplink Balance, please prepare the following:

- At least one Internet/WAN access account.
- For each network connection, one 10/100BaseT UTP cable with RJ45 connector, or one 1000BaseT Cat5E UTP cable for the Gigabit port on the Balance 390/580/710/1350, or one USB modem for the USB WAN port on Balance 380/390/580/710/1350.
- A computer with TCP/IP network protocol and a web browser installed. Supported browsers include Microsoft Internet Explorer 7 or above, Mozilla Firefox 3.0 or above, Apple Safari 3.1.1 or above, and Google Chrome 2.0 or above.

6.2 Constructing the Network

At the high level, construct the network according to the following steps:

1. With an Ethernet cable, connect a computer to one of the LAN ports on the Peplink Balance. For Peplink Balance 20, 30, 210 and 310, repeat with different cables for up to 4 computers to be connected.
2. With another Ethernet cable, connect the WAN/broadband modem to one of the WAN ports on the Peplink Balance. Repeat using different cables to connect up to 2, 3, 5, 7 or 13 WAN/broadband connections with the Peplink Balance 20, 30, 210, 310, 380, 390, 580, 710 and 1350, respectively, or connect a USB modem to the USB WAN port on the Peplink Balance 20/30/380/390/580/710/1350.
3. For Peplink Balance 20, 30, 210 and 310, connect the provided power adapter to the power connector on the Peplink Balance, and then plug the power adapter into a power outlet. For Peplink Balance 380, 390, 580, 710 and 1350, connect the provided power cord to the AC power connector on the Peplink Balance, and then plug the power cord into a power outlet.

The following figure schematically illustrates the configuration that results:

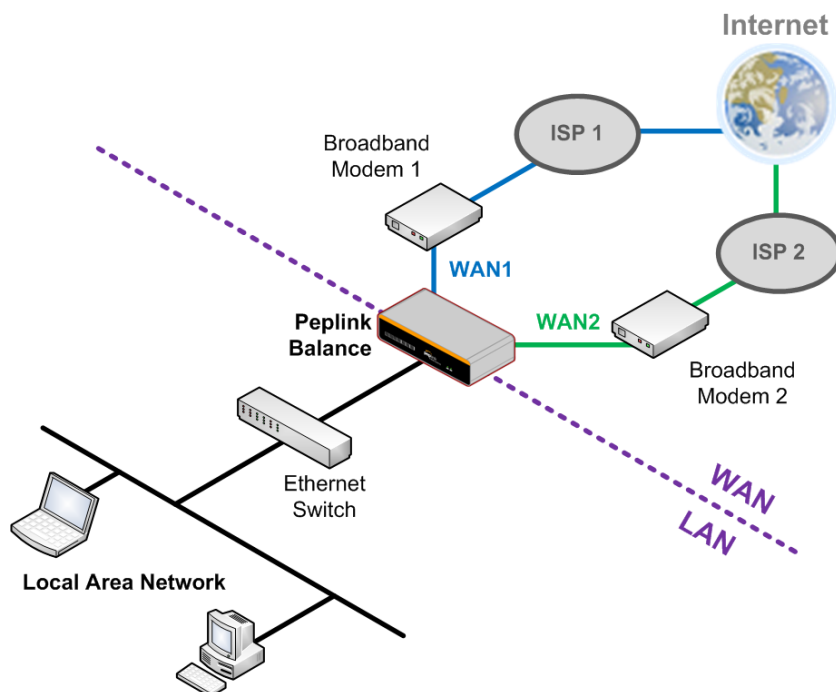

6.3 Configuring the Network Environment

To ensure that Peplink Balance works properly in the LAN environment and can access the Internet via the WAN connections, please refer to the following setup procedures:

- LAN Configuration
For basic configuration, refer to Section 7, **Basic Configuration**.
For advanced configuration, refer to Section 8, **Configuration of LAN Interface**.
- WAN Configuration
For basic configuration, refer to Section 7, **Basic Configuration**.
For advanced configuration, refer to Section 10, **Configuration of WAN Interface(s)**.

7 Basic Configuration

7.1 Connecting to Web Admin Interface

1. Start a web browser on a computer that is connected with Peplink Balance through LAN.
2. To connect to Web Admin of Peplink Balance, enter the following LAN IP address in the address field of the web browser:

http://192.168.1.1

(This is the default LAN IP address of Peplink Balance.)

3. Enter the following to access the Web Admin Interface.

User Name: admin

Password: admin

(This is the default Admin User login of Peplink Balance. The Admin and Read-only User Password can be changed at **System > Admin Security** of the Web Admin Interface.)

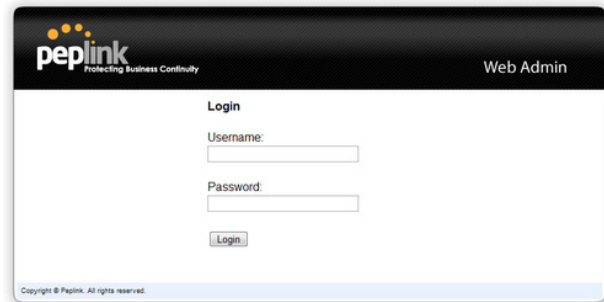

4. After successful login, the **Dashboard** of Web Admin Interface will be displayed. It looks similar to the following:

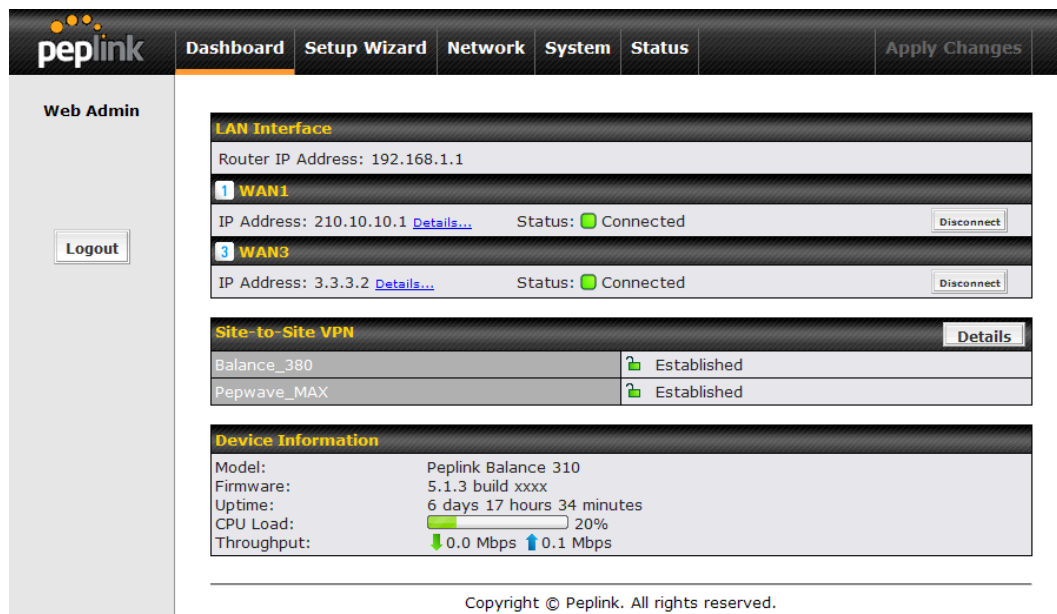

Important Note

Configuration changes (e.g. WAN, LAN, Admin settings, etc.) take effect after clicking the **Apply Changes** button on each page's header. The **Apply Changes** button causes the changes to be saved and applied.

7.2 Configuration with Setup Wizard

The Setup Wizard of Peplink Balance simplifies the task of configuring WAN connection(s) by guiding the configuration process step by step.

To begin, click **Setup Wizard** after connecting to Web Admin Interface.



Click **Next** to begin.

Setup Wizard > WAN Setup > Step 1

Welcome to Setup Wizard!

The Setup Wizard will guide you through the WAN port(s) configuration step by step. This wizard is designed to simplify the process in configuring your device and connecting it to the Internet.

Click *Next* to begin.

Select **YES** if you want to set up Drop-in mode in Setup Wizard. (Drop-in mode is only available on Peplink Balance 210 or above.)

Setup Wizard > WAN Setup > Step 2

Drop-in Mode ?	
Do you want to setup drop-in mode?	<input checked="" type="radio"/> Yes <input type="radio"/> No
Which WAN port do you want to enable drop-in mode?	WAN 1 ▾

Click on the appropriate check box(es) to select the WAN connection(s) to be configured. If you have chosen to configure Drop-in mode in Setup Wizard, the box of WAN port that is to be configured in Drop-in mode will be checked by default.

Setup Wizard > WAN Setup > Step 3

Choose the WAN port(s) to be configured.

WAN Ports ?	
WAN 1 (Drop-in)	<input checked="" type="checkbox"/>
WAN 2	<input type="checkbox"/>
WAN 3	<input type="checkbox"/>
Mobile Internet	<input type="checkbox"/>

Note

Mobile Internet connection is only available on Peplink Balance 20, 30, 380, 390, 580, 710 and 1350.

If **Drop-in mode** is going to be configured, Setup Wizard will move on to Drop-in Settings.

Setup Wizard > WAN Setup > Step 4

Enter the parameters of Drop-in Settings for WAN 1.

Drop-in Settings	
IP Address	<input type="text"/>
Subnet Mask	255.255.255.0 (/24) ▾
Default Gateway	<input type="text"/>
DNS Servers	DNS server 1: <input type="text"/> DNS server 2: <input type="text"/>
Upload Bandwidth	100 <input type="text"/> Mbps ▾
Download Bandwidth	100 <input type="text"/> Mbps ▾

If **Mobile Internet Connection** is checked, Setup Wizard will move on to Operator settings.

Setup Wizard > WAN Setup > Step 3

Select whether Operator Settings for Mobile Internet will be automatically detected or customized.

Operator Settings (for HSPA/EDGE/GPRS only) ?	
Settings	Select
Auto	<input type="radio"/>
Custom	<input checked="" type="radio"/>

If **Custom Mobile Operator Settings** is selected, APN parameters are required to be entered. Some service providers may charge a fee for connecting to a different APN. Please consult the service provider for the correct settings.

Setup Wizard > WAN Setup > Step 4

Enter the parameters of Mobile Operator Settings for Mobile Internet.

Mobile Operator Settings ?	
APN	<input type="text"/>
Login ID	<input type="text"/>
Password	<input type="text"/>
Dial Number	<input type="text"/>

Select the connection type for WAN connection(s) from the following screen:

Setup Wizard > WAN Setup > Step 3

Choose a connection method for WAN1.

Connection Method ?	
Method	Select
Static IP	<input type="radio"/>
DHCP	<input checked="" type="radio"/>
PPPoE	<input type="radio"/>
Disable	<input type="radio"/>

Depending on the selection of connection type, further configuration may be needed. For example, PPPoE and Static IP require additional settings for the selected WAN port. Please refer to **Section 10, Configuration of WAN Interface(s)** for details on setting up DHCP, Static IP and PPPoE.

Click on the appropriate check box(es) to select the preferred WAN connection(s). Connection(s) not selected in this step will be used as back up only. Click **Next >>** to continue.

Setup Wizard > WAN Setup > Step 6

Choose the preferred WAN Port(s) that is to be used as primary connection. The port(s) not selected in this step will only be used when none of the connection of the preferred port is up.

Preferred WAN Port Selection	
Port	Preferred
WAN 1	<input checked="" type="checkbox"/>
WAN 2	<input checked="" type="checkbox"/>
WAN 3	<input checked="" type="checkbox"/>
Mobile Internet	<input type="checkbox"/>

Choose the time zone of your Country/Region. Check the box **Show all** to display all time zone options.

Setup Wizard > WAN Setup > Step 6

Choose time zone of your Country / Region.

Time Zone Settings	
Time Zone	(GMT-08:00) Pacific Time (US & Canada)
	<input checked="" type="checkbox"/> Show all

Check in the following screen to make sure all settings have been configured correctly, and then click **Save Settings** to confirm.

Setup Wizard > WAN Setup > Final Step

Confirm the WAN connection(s) configuration below. Click *Back* to modify the configuration settings in previous steps. Click *Save Settings* when you are done.

Summary of WAN Connection(s) Configuration	
2. WAN2	
Enable	No
4. Mobile Internet	
Connection Method	PPP
Operator Settings	Auto
Preferred WAN Connection(s)	
Connections	1. WAN1 3. WAN3
Time Zone Settings	
Time Zone	(GMT-08:00) Pacific Time (US & Canada)

<< Back

Save Settings

Cancel

After finishing the last step in the Setup Wizard, please click **Apply Changes** on the page header to allow the configuration changes to take effect.

7.3 Advanced Setup

Advanced settings can be configured from the **Network** menu.

WAN connections can be configured by entering the corresponding WAN connection information at:
Network > Interfaces > WAN

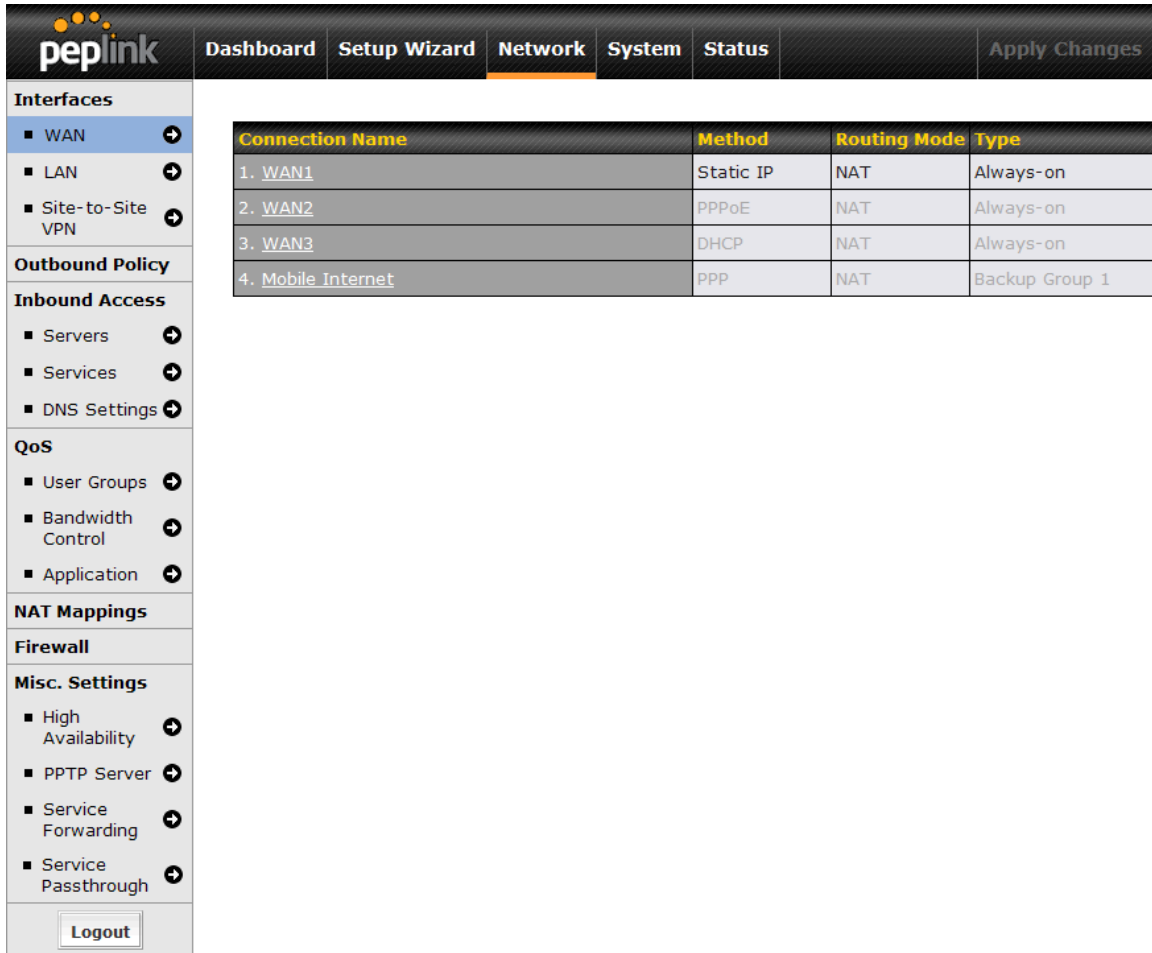

Connection Name	Method	Routing Mode	Type
1. WAN1	Static IP	NAT	Always-on
2. WAN2	PPPoE	NAT	Always-on
3. WAN3	DHCP	NAT	Always-on
4. Mobile Internet	PPP	NAT	Backup Group 1

Tip

Please refer to **Section 10, Configuration of WAN Interface(s)**, for details on setting up DHCP, Static IP, PPPoE, GRE, and Mobile Internet Connection.

8 Configuration of LAN Interface

The LAN Interface settings are located at: **Network > Interfaces > LAN**

IP Settings	
IP Address *	192.168.1.2
Subnet Mask *	255.255.0.0 (/16)
Speed	100Mbps Full Duplex <input checked="" type="checkbox"/> Advertise Speed

Drop-In Mode Settings	
Enable	<input checked="" type="checkbox"/>
WAN for Drop-In Mode	WAN 1
WAN Default Gateway	192.168.1.1 <input checked="" type="checkbox"/> I have other host(s) on WAN segment Host IP Address(es) 192.168.1.123 - <input type="text"/> <input type="button" value="↓"/> <input type="text"/> <input type="button" value="Delete"/>
WAN DNS Servers	DNS server 1: <input type="text"/> DNS server 2: <input type="text"/>
NOTE: The DHCP Server Settings will be overwritten.	
The following WAN 1 settings will be overwritten: Enable, Connection Method, Routing Mode, Connection Type, MTU, Health Check, Additional Public IP, and Dynamic DNS Settings.	
The PPTP Server will be disabled.	
Tip: please review the DNS Forwarding setting under the Service Forwarding section.	

DHCP Server Settings													
DHCP Server	<input checked="" type="checkbox"/> Enable												
IP Range	192.168.1.10 - 192.168.1.250												
Subnet Mask	255.255.255.0 (/24)												
Lease Time	1 Days 0 Hours 0 Mins 0 Seconds												
DNS Servers	<input type="checkbox"/> Assign DNS server automatically DNS server 1: <input type="text"/> DNS server 2: <input type="text"/>												
WINS Servers	<input checked="" type="checkbox"/> Assign WINS server <input type="radio"/> Built-in <input checked="" type="radio"/> External WINS server 1: <input type="text"/> WINS server 2: <input type="text"/>												
Extended DHCP Option	<table border="1"> <thead> <tr> <th>Option</th> <th>Value</th> </tr> </thead> <tbody> <tr> <td colspan="2" style="text-align: center;">No Extended DHCP Option</td> </tr> <tr> <td colspan="2" style="text-align: center;"><input type="button" value="Add"/></td> </tr> </tbody> </table>	Option	Value	No Extended DHCP Option		<input type="button" value="Add"/>							
Option	Value												
No Extended DHCP Option													
<input type="button" value="Add"/>													
DHCP Reservation	<table border="1"> <thead> <tr> <th>Name</th> <th>MAC Address</th> <th>Static IP</th> </tr> </thead> <tbody> <tr> <td>Manager's desktop</td> <td>00:11:aa:22:bb:33</td> <td>192.168.1.100</td> </tr> <tr> <td><input type="button" value="X"/></td> <td></td> <td></td> </tr> <tr> <td><input type="button" value="+"/></td> <td></td> <td></td> </tr> </tbody> </table>	Name	MAC Address	Static IP	Manager's desktop	00:11:aa:22:bb:33	192.168.1.100	<input type="button" value="X"/>			<input type="button" value="+"/>		
Name	MAC Address	Static IP											
Manager's desktop	00:11:aa:22:bb:33	192.168.1.100											
<input type="button" value="X"/>													
<input type="button" value="+"/>													

Static Route Settings										
Static Route	<table border="1"> <thead> <tr> <th>Destination Network</th> <th>Subnet Mask</th> <th>Gateway</th> </tr> </thead> <tbody> <tr> <td><input type="text"/></td> <td><input type="text"/></td> <td><input type="text"/></td> </tr> <tr> <td><input type="button" value="+"/></td> <td></td> <td></td> </tr> </tbody> </table>	Destination Network	Subnet Mask	Gateway	<input type="text"/>	<input type="text"/>	<input type="text"/>	<input type="button" value="+"/>		
Destination Network	Subnet Mask	Gateway								
<input type="text"/>	<input type="text"/>	<input type="text"/>								
<input type="button" value="+"/>										

WINS Server Settings		
Enable	<input type="checkbox"/>	



DNS Proxy Settings						
DNS Caching	<input type="checkbox"/>					
Use Google DNS Server as Backup	<input type="checkbox"/>					
Local DNS Records	<table border="1"> <thead> <tr> <th>Host Name</th> <th>IP Address</th> </tr> </thead> <tbody> <tr> <td></td> <td></td> </tr> </tbody> </table>	Host Name	IP Address			<input type="button" value="+"/>
Host Name	IP Address					

* Required

LAN Settings	
IP Address & Subnet Mask	The IP address of Peplink Balance on LAN
Speed	<p>This setting specifies the speed of the LAN Ethernet Port. By default, Auto is selected and the appropriate data speed is automatically detected by Peplink Balance.</p> <p>In the event of negotiation issues, the port speed can be manually specified to circumvent the issues. You can also choose whether or not to advertise the speed to the peer by selecting the Advertise Speed checkbox.</p>

Drop-in Mode Settings (Available only on Peplink Balance 210 or above)	
Default Gateway	<p>Drop-in Mode eases the installation of Peplink Balance on a live network between the existing Firewall and Router, such that no configuration changes are required on existing equipment.</p> <p>Please refer to Section 9 Drop-in Mode for details.</p>
WAN for Drop-In Mode	Select the WAN port to be used for Drop-in mode. If the WAN port for LAN Bypass is selected, High Availability feature will be disabled automatically.
WAN Default Gateway	Enter the WAN router's IP address in this field. If there are more hosts other than the router on the WAN segment, check the box I have other host(s) on WAN segment and enter the IP address of the hosts that needs to access LAN devices or to be accessed by others.
WAN DNS Servers	Enter the selected WAN's corresponding DNS server IP addresses.



DHCP Server Settings	
DHCP Server	<p>When this setting is enabled, the DHCP server of Peplink Balance automatically assigns an IP address to each computer that is connected via LAN and is configured to obtain an IP address via DHCP.</p> <p>Peplink Balance's DHCP server can prevent IP address collision on LAN.</p>
IP Range & Subnet Mask	This setting allocates a range of IP address that will be assigned to LAN computers by the DHCP server of Peplink Balance.

Lease Time	This setting specifies the length of time throughout which an IP address of a DHCP client remains valid. Upon expiration of the Lease Time, the assigned IP address will no longer be valid and the renewal of the IP address assignment will be required.
DNS Servers	This option allows you to input the DNS server addresses to be offered to the DHCP clients. If Assign DNS server automatically is selected, the Peplink Balance's built-in DNS server address (i.e. LAN IP address) will be offered.
WINS Server	<p>This option allows you to specify the Windows Internet Name Service (WINS) server. You may choose to use the built-in WINS server or external WINS servers. When this unit is Site-to-Site VPN connected, other VPN peers can share this unit's built-in WINS server by entering this unit's LAN IP address in their DHCP WINS Servers setting. Therefore, all PC clients in the VPN can resolve the NetBIOS names of other clients in remote peers.</p> <p>If the option Assign WINS Server – Built-in is checked, the option WINS Server Settings below DHCP Server Settings will be enabled automatically.</p> <p>If you have enabled this option, a list of WINS clients will be displayed at Status > WINS Clients.</p>
Extended DHCP Option	<p>In addition to standard DHCP options (e.g. DNS server address, gateway address, subnet mask), you can specify the value of additional Extended DHCP Options defined in RFC 2132. In this case, you can pass additional configuration information to LAN hosts.</p> <p>To define an Extended DHCP Option, click the Add button, choose the option that you want to define and enter its value. For values that are in IP address list format, you can enter one IP address per line in the provided text area input control. Each option is allowed to be defined once only.</p>
DHCP Reservation	<p>This setting reserves the assignment of fixed IP addresses for a list of computers on the LAN. The computers to be assigned fixed IP addresses on the LAN are identified by their MAC addresses.</p> <p>The fixed IP address assignment is displayed as a cross-reference list between the computers' Name, MAC addresses and fixed IP addresses.</p> <p>The field Name (an optional field) is for you to define a name to represent the device. MAC addresses should be in the format of 00:AA:BB:CC:DD:EE</p> <p>Press  to create a new record. Press  to remove a record.</p>

WINS Server Settings

Enable	Check the box to enable the WINS Server. A list of WINS clients will be displayed at Status > WINS Clients .
---------------	--

Static Route Settings

Static Route	<p>This table is for defining static routing rules for the LAN segment. A static route consists of the network address, subnet mask, and gateway address. The address and subnet mask values are in the format of w.x.y.z</p> <p>The local LAN subnet and subnets behind the LAN will be advertised to the VPN. Remote routes sent over the VPN will also be accepted. Any VPN member will be able to route to the local subnets.</p> <p>Press  to create a new route. Press  to remove a route.</p>
---------------------	---

DNS Proxy Settings

DNS Caching

This field is to enable DNS caching on the built-in DNS proxy server. When the option is enabled, queried DNS replies will be cached until the records' TTL has been reached. This feature can help improve the DNS lookup time by storing all received DNS results for a faster DNS response time. However, it cannot return the most updated result for those frequently updated DNS records.

By default, it is **disabled**.

Use Google DNS Server as Backup



When this option is **enabled**, the DNS proxy server will forward DNS requests to [Google's Public DNS Servers](#) in the case if all WAN connections' DNS servers become unavailable.

By default, it is **disabled**.

Local DNS Records

This table is for defining custom local DNS records.

A static local DNS record consists of a Host Name and an IP Address. When looking up the Host Name from the LAN to LAN IP of Peplink Balance, the corresponding IP Address will be returned.

Press  to create a new record. Press  to remove a record.

9 Drop-in Mode

Drop-in Mode (or transparent bridging mode) eases the installation of Peplink Balance on a live network between the firewall and router, such that changes to the settings of existing equipment are not required. Drop-in Mode is NOT applicable to Balance 20 and 30.

The following diagram illustrates the Drop-in Mode setup:

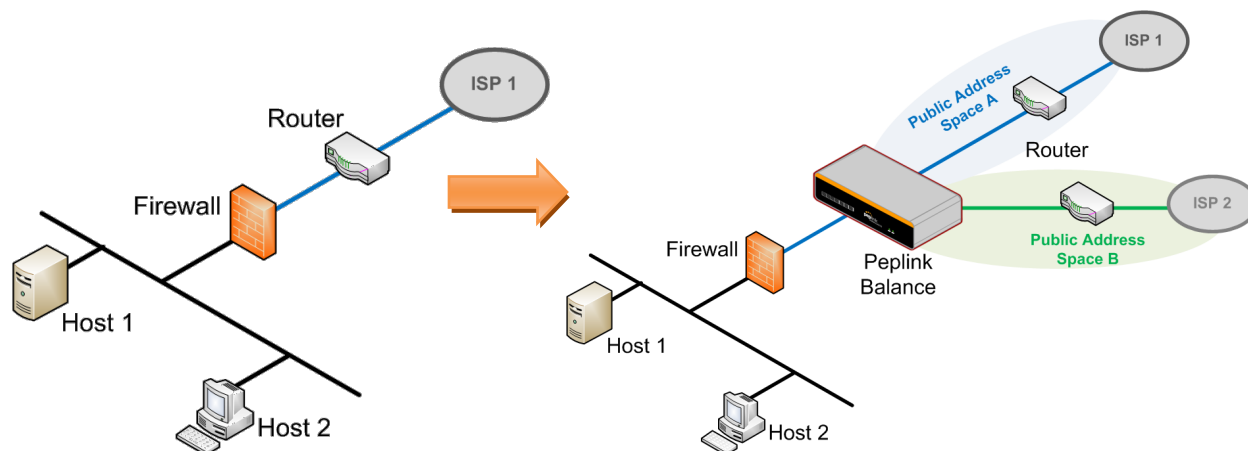

Check the box to **Enable** the Drop-in Mode. After enabling this feature and selecting the WAN for Drop-in mode, various settings including the WAN's connection method and IP address will be automatically updated.

When Drop-in Mode is enabled, the LAN and the WAN for Drop-in Mode ports will be bridged. Traffic going in between the LAN hosts and WAN router will be forwarded to each other. In this case, the hosts on both sides will not notice any IP or MAC address change.

After successfully setting up Peplink Balance as part of the network via Drop-in Mode, a Peplink Balance 210 will accommodate one additional WAN connection; 310, 380, or 390 will accommodate two, 580 will accommodate four, 710 will accommodate six, and 1350 will accommodate twelve additional WAN connections respectively.

IMPORTANT NOTE for customers using Drop-in Mode and going to upgrade from firmware 4.8. 2 to 5.0 or above

MAC address passthrough for Drop-in Mode is implemented in firmware 5.0. If Drop-in Mode is enabled when user is upgrading from previous firmware version, the ARP tables on the hosts on LAN and WAN segments have to be flushed once or the hosts have to be rebooted. Otherwise, hosts on one side may not be able to reach hosts on the other side of Peplink Balance until the old ARP records expire. Units without enabling Drop-in Mode are not affected.

NOTE

PPTP server will be disabled under Drop-in Mode.

To enable Drop-in Mode, perform the following steps.

IP Settings	
IP Address *	210.10.10.5
Subnet Mask *	255.255.255.0 (/24)
Speed	100Mbps Full Duplex <input checked="" type="checkbox"/> Advertise Speed

Drop-In Mode Settings	
Enable	<input checked="" type="checkbox"/>
WAN for Drop-In Mode	WAN 1
WAN Default Gateway	210.10.10.1 <input checked="" type="checkbox"/> I have other host(s) on WAN segment Host IP Address(es) 210.10.10.4 - <input type="text"/> 210.10.10.3 210.10.10.4 <input type="button" value="Delete"/>
WAN DNS Servers	DNS server 1: 10.1.1.1 DNS server 2: <input type="text"/>

NOTE: The DHCP Server Settings will be overwritten.

The following WAN 1 settings will be overwritten: Enable, Connection Method, Routing Mode, Connection Type, MTU, Health Check, Additional Public IP, and Dynamic DNS Settings.

The PPTP Server will be disabled.

Tip: please review the DNS Forwarding setting under the Service Forwarding section.

1. Check the **Enable** box under Drop-in Mode located at: **Network > Interfaces > LAN**. (After checking the **Enable** box, most network settings for WAN1 will be hidden from Web Administration Interface.)
2. Put the IP address of the WAN1 router in the **Default Gateway** field. Ensure that the Peplink Balance IP subnet is the same as the Firewall's WAN port and the Router's LAN port.
3. If there are hosts other than the router existing on the WAN segment of Peplink Balance, check the **I have other host(s) on WAN segment** box, enter the IP address(es) of the host(s), and then click the down-arrow to add the hosts.

The following diagram illustrates:

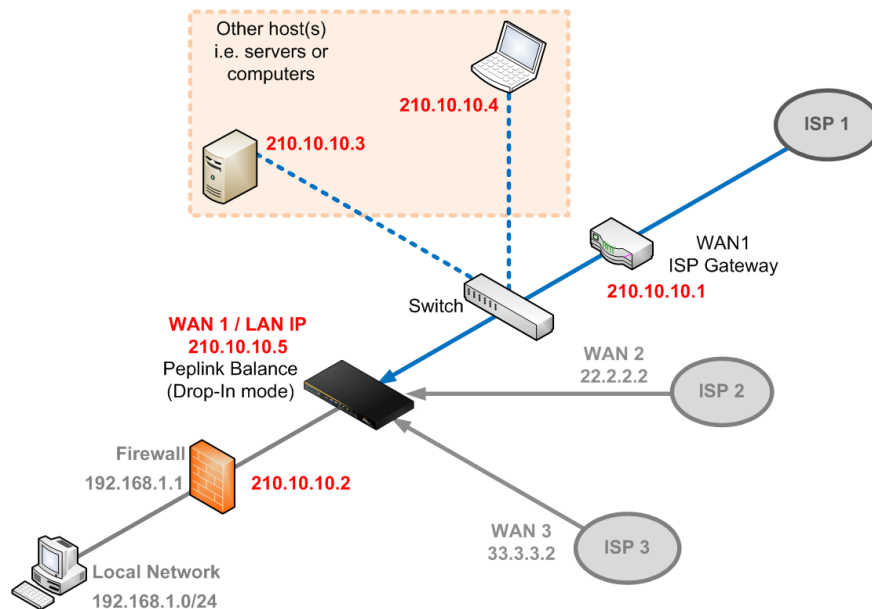

Important Note

Starting from firmware version 5.0, Drop-in mode can be configured not only on WAN1, but on any WAN ports. Please be noted that still only one WAN port can be configured in Drop-in mode.

If you have selected the LAN Bypass port (which is currently only available on WAN1 of Balance 390/1350 and WAN5 of Balance 580) as the WAN for Drop-in Mode, High Availability feature will be DISABLED automatically.

Tip

Want to know more about Drop-in mode? Visit our [YouTube Channel](#) for video tutorials!

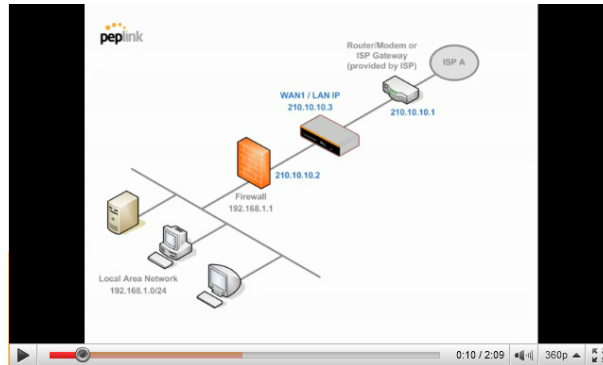

<http://www.youtube.com/PeplinkChannel#p/u/9/xHTLcCXsqTc>

10 Configuration of WAN Interface(s)

The WAN interface settings are located at: **Network > Interfaces > WAN**

By clicking a connection name, connection settings of that WAN can be modified.

10.1 Connection Method(s)

There are five possible connection methods:

- DHCP
- Static IP
- PPPoE
- GRE
- Mobile Internet Connection
(available only with Peplink Balance 20/30/380/390/580/710/1350, please refer to Section 10.1.5 for details.)

The connection method and details are determined by, and can be obtained from, the ISP.

Connection Settings	
WAN Connection Name *	WAN1
Enable	<input checked="" type="radio"/> Yes <input type="radio"/> No
Connection Method	DHCP Click here to edit Connection settings
Routing Mode	<input checked="" type="radio"/> NAT
Connection Type	<input type="radio"/> Always-on <input checked="" type="radio"/> Backup Priority Group 1 (Highest)
Reply to ICMP PING	<input checked="" type="checkbox"/> Enable
Upload Bandwidth *	100 Mbps
Download Bandwidth *	100 Mbps

Physical Interface Settings	
Speed	Auto
MTU	<input type="radio"/> Auto <input checked="" type="radio"/> Custom 1440 <input type="button" value="Default"/>
MSS	<input checked="" type="radio"/> Auto <input type="radio"/> Custom
MAC Address Clone	00 : 11 : 66 : 22 : 22 : CC <input type="button" value="Default"/>
VLAN	<input type="checkbox"/> Enable

Connection Settings							
WAN Connection Name	This field is for defining a name to represent this WAN connection.						
Enable	This field is for choosing whether to enable this WAN connection.						
Connection Method	<p>This option allows you to select the connection method for this WAN connection. Available options are:</p> <ul style="list-style-type: none"> • DHCP • Static IP • PPPoE • GRE • Mobile Internet Connection (available only with Peplink Balance 20, 30, and 380 or above) <p>See Sections 10.1.1, 10.1.2, 10.1.3, 10.1.4, 10.1.5 for configuration details of each connection method.</p>						
Routing Mode	<p>This field illustrates that NAT (Network Address Translation) will be applied to the traffic routing over this WAN connection. Option of IP Forwarding can only be chosen when the Connection Method is PPPoE.</p> <p>For further details, please refer to Appendix B, Routing under DHCP, Static IP, and PPPoE.</p>						
Connection Type	<p>This setting specifies the utilization of the WAN connection. The selection of Always-on results in the WAN connection to be used whenever it is available. If Backup Priority and a priority group are selected, the WAN connection is treated as a backup connection and is used only in the absence of available Always-on WAN connection(s) and higher priority backup connection(s).</p> <table border="1" style="width: 100%; border-collapse: collapse;"> <tr> <td style="padding: 2px;">Connection Type ?</td> <td style="padding: 2px;"><input type="radio"/> Always-on <input checked="" type="radio"/> Backup Priority</td> <td style="padding: 2px;">Group 1 (Highest) v</td> </tr> <tr> <td style="padding: 2px;">Reply ICMP Ping Requests ?</td> <td style="padding: 2px;"><input checked="" type="checkbox"/> Enable</td> <td style="padding: 2px;">Group 1 (Highest) Group 2 (Lowest)</td> </tr> </table> <p>The default and recommended Connection Type is Always-on.</p>	Connection Type ?	<input type="radio"/> Always-on <input checked="" type="radio"/> Backup Priority	Group 1 (Highest) v	Reply ICMP Ping Requests ?	<input checked="" type="checkbox"/> Enable	Group 1 (Highest) Group 2 (Lowest)
Connection Type ?	<input type="radio"/> Always-on <input checked="" type="radio"/> Backup Priority	Group 1 (Highest) v					
Reply ICMP Ping Requests ?	<input checked="" type="checkbox"/> Enable	Group 1 (Highest) Group 2 (Lowest)					
Reply to ICMP Ping	<p>If this field is disabled, the WAN connection will not respond to ICMP Ping requests. By default, this is enabled.</p>						
Upload Bandwidth	<p>This setting specifies the data bandwidth in the outbound direction from the LAN through the WAN interface. This value is provided by the ISP and should reflect the actual speed the WAN gets.</p> <p>This value is referenced when default weight is chosen for outbound traffic and traffic prioritization. A correct value can result in effective traffic prioritization and efficient use of upload bandwidth.</p>						
Download Bandwidth	<p>This setting specifies the data bandwidth in the inbound direction from the WAN interface to the LAN. This value is provided by the ISP and should reflect the actual speed the WAN gets.</p> <p>This value is referenced as the default weight value when using the custom rule Default (Auto), the algorithm Least Used, or the algorithm Persistence (Auto) in Outbound Policy with Managed by Custom Rules chosen (see Section 12.2).</p>						

Physical Interface Settings	
Speed	<p>This setting specifies port speed and duplex configurations of the WAN Port. By default, Auto is selected and the appropriate data speed is automatically detected by Peplink Balance.</p> <p>In the event of negotiation issues, the port speed can be manually specified to circumvent the issues. You can also choose whether or not to advertise the speed to the peer by selecting the Advertise Speed checkbox.</p>
MTU	<p>This setting specifies the Maximum Transmission Unit. By default, MTU is set to Custom 1440.</p> <p>You may adjust the MTU value by editing the text field. Click Default to restore the default MTU value. Select Auto and the appropriate MTU value will be automatically detected. The auto-detection will run each time when the WAN connection establishes.</p>
MSS	<p>This setting should be configured based on the maximum payload size that the local system can handle. The MSS (Maximum Segment Size) is computed from the MTU minus 40 bytes for TCP over IPv4.</p> <p>If MTU is set to Auto, the MSS will also be set automatically. By default, MSS is set to Auto.</p>
MAC Address Clone	<p>This setting allows you to configure the MAC address. Some service providers (e.g. cable providers) identify the client's MAC address and require the client to always use the same MAC address to connect to the network. In such cases, change the WAN interface's MAC address to the original client PC's one via this field.</p> <p>The default MAC Address is a unique value assigned at the factory. In most cases, the default value is sufficient. Clicking the Default button restores the MAC Address to the default value.</p>
VLAN	<p>Some service providers require the router to enable VLAN tagging for Internet traffic. If it is required by your service provider, you can enable this field and enter the VLAN ID that the provider requires.</p> <p><i>Note: Leave this field disabled if you are not sure.</i></p>

10.1.1 DHCP Connection

The DHCP connection method is suitable if the ISP provides an IP address automatically by DHCP (e.g. Cable, Metro Ethernet, etc.).

DHCP Settings	
DNS Servers	<input checked="" type="checkbox"/> Obtain DNS server address automatically <input type="checkbox"/> Use the following DNS server address(es) DNS server 1: <input type="text"/> DNS server 2: <input type="text"/>
Hostname (Optional) ?	<input type="text"/> <input type="checkbox"/> Use custom hostname

DHCP Settings	
DNS Servers	<p>Each ISP may provide a set of DNS servers for DNS lookups. This setting specifies the DNS (Domain Name System) Servers to be used when a DNS lookup is routed through this connection.</p> <p>Selecting Obtain DNS server address automatically results in the DNS Servers to be assigned by the WAN DHCP Server to be used for outbound DNS lookups over the connection. (The DNS Servers are obtained along with the WAN IP address assigned from the DHCP server.)</p> <p>When Use the following DNS server address(es) is selected, you may enter custom DNS server addresses for this WAN connection into the DNS server 1 and DNS server 2 fields.</p>
Hostname (Optional)	<p>If your service provider's DHCP server requires you to supply a hostname value upon acquiring an IP address, you may enter the value here. If your service provider does not provide you with the value, you can safely bypass this option.</p>

Please refer to Section 10.2, 10.3, 10.4, and 10.5 for details about **WAN Health Check**, **Bandwidth Allowance Monitor**, **Additional Public IP Settings**, and **Dynamic DNS Settings** respectively.

10.1.2 Static IP Connection

The Static IP connection method is suitable if the ISP provides a static IP address to connect directly.

Static IP Settings ?	
IP Address *	<input type="text"/>
Subnet Mask *	255.255.255.0 (/24) ▾
Default Gateway *	<input type="text"/>
DNS Servers	<input checked="" type="checkbox"/> Use the following DNS server address(es) DNS server 1: <input type="text"/> DNS server 2: <input type="text"/>

Static IP Settings	
IP Address / Subnet Mask / Default Gateway	<p>These settings specify the information required in order to communicate on the Internet via a fixed Internet IP address.</p> <p>The information is typically determined by and can be obtained from the ISP.</p>
DNS Servers	<p>Each ISP may provide a set of DNS servers for DNS lookups. This field specifies the DNS (Domain Name System) Servers to be used when a DNS lookup is routed through this connection.</p> <p>You can input the ISP provided DNS server addresses into the DNS server 1 and DNS server 2 fields. If no address is entered here, this link will not be used for DNS lookups.</p>

Please refer to Section 10.2, 10.3, 10.4, and 10.5 for details about **WAN Health Check**, **Bandwidth Allowance Monitor**, **Additional Public IP Settings**, and **Dynamic DNS Settings** respectively.

10.1.3 PPPoE Connection

This connection method is suitable if ISP provides login ID / password to connect via PPPoE.

PPPoE Settings	
PPPoE User Name *	<input type="text"/>
PPPoE Password	<input type="password"/>
Confirm PPPoE Password	<input type="password"/>
Service Name (optional)	<input type="text"/> <small>Leave it blank unless it's provided by ISP</small>
DNS Servers	<input checked="" type="checkbox"/> Obtain DNS server address automatically <input type="checkbox"/> Use the following DNS server address(es) DNS server 1: <input type="text"/> DNS server 2: <input type="text"/>

PPPoE Settings	
PPPoE User Name / Password	Enter the required information in these fields in order to connect via PPPoE to the ISP. The parameter values are determined by and can be obtained from the ISP.
Confirm PPPoE Password	Verify your password by entering it again in this field.
Service Name (Optional)	Service Name is a PPPoE parameter which is provided by the ISP. <i>Note: Leave this field blank unless it is provided by your ISP.</i>
DNS Servers	<p>Each ISP may provide a set of DNS servers for DNS lookups. This setting specifies the DNS (Domain Name System) Servers to be used when a DNS lookup is routed through this connection.</p> <p>Selecting Obtain DNS server address automatically results in the DNS Servers assigned by the PPPoE server to be used for outbound DNS lookups over the WAN connection. (The DNS Servers are obtained along with the WAN IP address assigned from the PPPoE server.)</p> <p>When Use the following DNS server address(es) is selected, you can put custom DNS server addresses for this WAN connection into the DNS server 1 and DNS server 2 fields.</p>

Please refer to Section 10.2, 10.3, 10.4, and 10.5 for details about **WAN Health Check**, **Bandwidth Allowance Monitor**, **Additional Public IP Settings**, and **Dynamic DNS Settings** respectively.

Note
PPPoE connection made from a firewall does not work with Drop-in mode.

10.1.4 GRE Connection

The GRE connection method is suitable if the ISP provides GRE tunnel access through a private network to the Internet.

GRE Settings	
WAN IP Address *	<input type="text"/>
WAN Subnet Mask *	255.255.255.0 (/24) ▼
WAN Default Gateway *	<input type="text"/>
Remote GRE Host *	<input type="text"/>
Tunnel Local IP Address *	<input type="text"/>
Tunnel Remote IP Address *	<input type="text"/>
Outgoing NAT IP Address *	<input type="text"/>
DNS Servers	<input checked="" type="checkbox"/> Use the following DNS server address(es) DNS server 1: <input type="text"/> DNS server 2: <input type="text"/>

GRE Settings	
GRE Settings	<p>Please refer to the following sections for further details:</p> <ul style="list-style-type: none"> • Section 10.1.4.1, • Routing under GRE via Network Address Translation (NAT) • Section 10.1.4.2, Routing under GRE via IP Forwarding <p>The values for DNS server 1 and DNS server 2 are typically determined by, and can be obtained from the ISP.</p>
DNS Servers	<p>Each ISP may provide a set of DNS servers for DNS lookups. This field specifies the DNS (Domain Name System) Servers to be used when a DNS lookup is routed through this connection.</p> <p>You can input the ISP provided DNS server addresses into the DNS server 1 and DNS server 2 fields. If no address is entered here, this link will not be used for DNS lookups.</p>

Please refer to Section 10.2, 10.3, 10.4, and 10.5 for details about **WAN Health Check**, **Bandwidth Allowance Monitor**, **Additional Public IP Settings**, and **Dynamic DNS Settings** respectively.

10.1.4.1 Routing under GRE via Network Address Translation (NAT)

The following figure shows a typical scenario with Peplink Balance under the GRE connection mode and NAT routing mode:

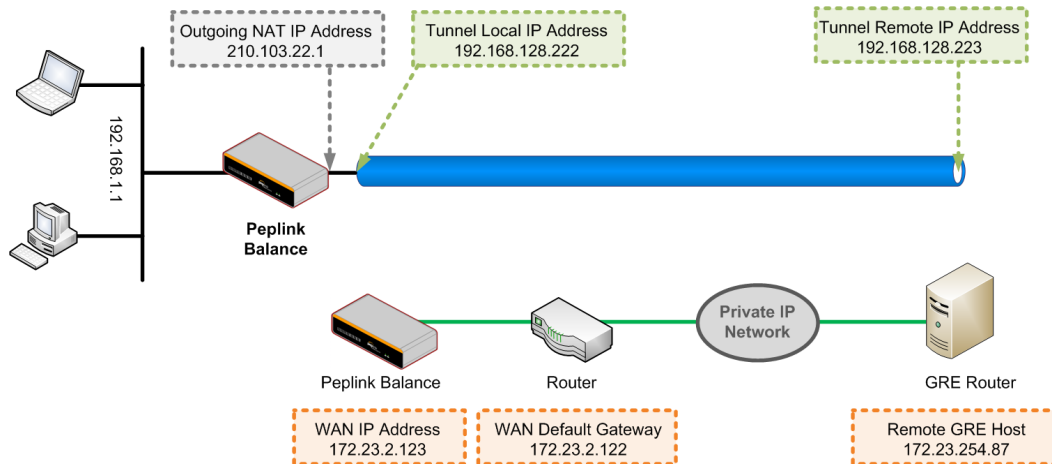

In this scenario, the IP address settings are as follows:

- WAN IP Address: 172.23.2.123
- Default Gateway: 172.23.2.122
- Remote GRE IP address: 172.23.254.87 (GRE router or host's IP address)
- Tunnel IP remote address: 192.168.128.223 (IP address of remote end of tunnel)
- Tunnel IP local address: 192.168.128.222 (IP address of local end of tunnel)
- Outgoing NAT IP address: 210.103.22.1 (This field is used for NAT routing mode only. For all outgoing traffic, the IP datagram will be sent via this IP address through the tunnel; as a result, the Outgoing NAT IP address is the public address that is seen by all external hosts on the WAN.)

The following figure shows the packet flow for Peplink Balance under GRE connection mode and NAT routing mode:

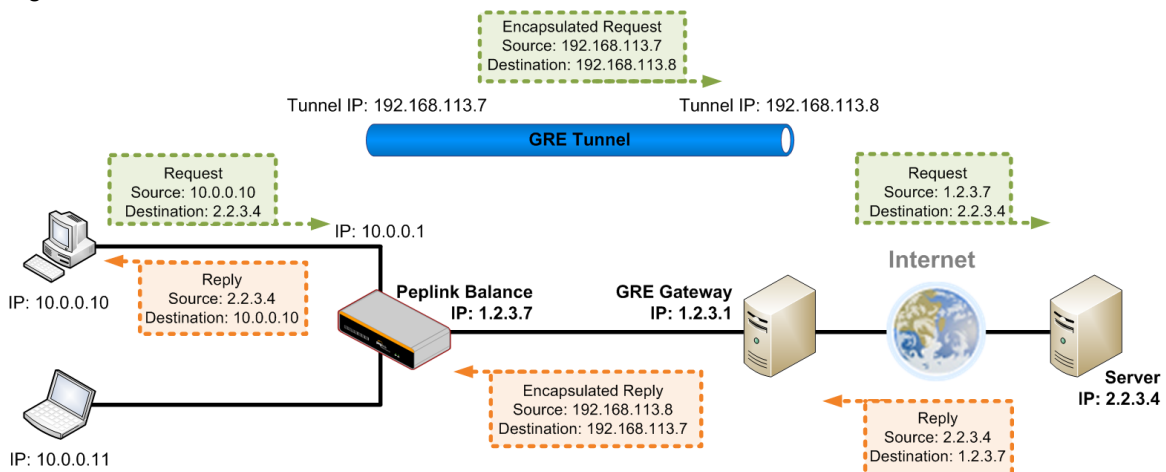

10.1.4.2 Routing under GRE via IP Forwarding

The following figure shows a typical scenario with Peplink Balance under the GRE connection mode and IP Forwarding routing mode:

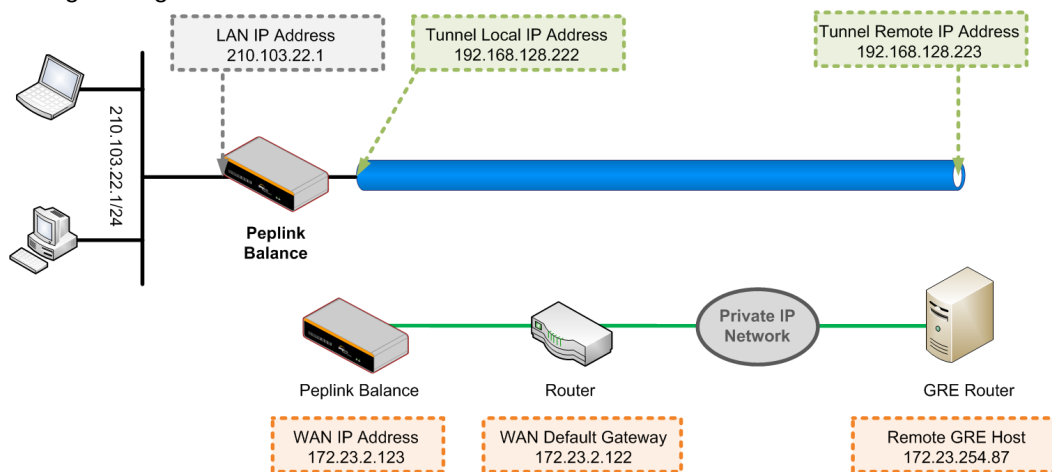

In this scenario, the IP address settings are as follows:

- WAN IP Address: 172.23.2.123
- Default Gateway: 172.23.2.122
- Remote GRE IP address: 172.23.254.87 (the GRE router or host's IP address)
- Tunnel IP remote address: 192.168.128.223 (IP address of remote end of tunnel)
- Tunnel IP local address: 192.168.128.222 (IP address of local end of tunnel)
- LAN IP Address: 210.103.22.1

The following figure shows the packet flow for Peplink Balance under GRE connection mode and IP Forwarding routing mode:

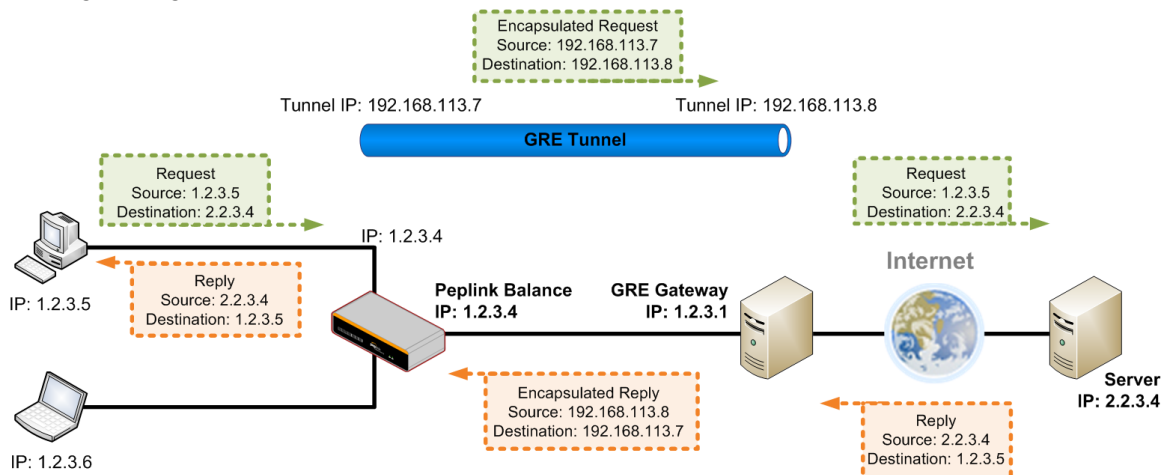

10.1.5 Mobile Internet Connection

(This section applies only to Peplink Balance 20, 30, 380, 390, 580, 710 and 1350)

The Mobile Internet Connection method is suitable for USB modem mobile connection such as 3G, EVDO, EDGE, and GPRS, etc. Currently it only applies to USB mobile WAN port. For the list of supported modems, please refer to Peplink 3G Modem Support page: <http://www.peplink.com/3g>

Connection Settings	
Enable	<input checked="" type="radio"/> Yes <input type="radio"/> No
Connection Type	<input type="radio"/> Always-on <input checked="" type="radio"/> Backup Priority Group 1 (Highest) ▼
Standby State	<input checked="" type="radio"/> Remain connected <input type="radio"/> Disconnect
GRE	<input checked="" type="checkbox"/> Enable
Reply to ICMP PING	<input checked="" type="checkbox"/> Enable
Operator Settings (for HSPA/EDGE/GPRS only)	<input type="radio"/> Auto <input checked="" type="radio"/> Custom Mobile Operator Settings APN: <input type="text"/> Login ID: <input type="text"/> Password: <input type="text"/> Dial Number: <input type="text"/>
Remote GRE Host	<input type="text"/>
Tunnel Local IP Address	<input type="text"/>
Tunnel Remote IP Address	<input type="text"/>
DNS Servers	<input checked="" type="checkbox"/> Use the following DNS server address(es) DNS server 1: <input type="text"/> DNS server 2: <input type="text"/>

Network Settings for Mobile Internet Connection	
Connection Type	<p>This setting specifies the utilization of the WAN connection.</p> <p>The selection of Always-on results in the WAN connection to be used whenever it is available. If Backup is selected, the WAN connection is treated as a backup connection and is used only in the absence of available Always-on WAN.</p> <p>The default and recommended Connection Type is Always-on.</p>
Standby State	<p>This option allows you to choose whether to remain the connection connected or disconnect when this WAN connection is no longer in the highest priority and has entered the standby state. When Remain connected is chosen, upon bringing up this WAN connection to active, it will be immediately available for use.</p>
GRE	Please refer to Section 10.1.4 for details.
Reply to ICMP Ping	<p>If this field is disabled, the WAN connection will not respond to ICMP Ping requests. By default, this is enabled.</p>
Operator Settings	<p>This setting applies to 3G / EDGE / GPRS modem only. It does not apply to EVDO / EVDO Rev. A modem.</p> <p>This allows you to configure the APN settings of your connection. If Auto is selected, Peplink Balance will automatically detect the APN, configure the modem, and make connection. You may change the APN settings by selecting Custom Mobile Operator Settings.</p> <p>The default and recommended Operator Settings is Auto.</p> <p>The correct values can be obtained from your mobile Internet service provider.</p>

DNS Servers

Each ISP may provide a set of DNS servers for DNS lookups. This field specifies the DNS Servers to be used when a DNS lookup is routed through this connection. You can input the ISP provided DNS server addresses into the **DNS server 1** and **DNS server 2** fields. If no address is entered here, this link will not be used for DNS lookups. This option is enabled automatically and it is required to define the DNS server when GRE is enabled.

Please refer to Section 10.2, 10.3, 10.4, and 10.5 for details about **WAN Health Check, Bandwidth Allowance Monitor, Additional Public IP Settings, and Dynamic DNS Settings** respectively.

10.1.6 Modem Specific Custom Settings

The following settings may be available depending on the modem model.

Modem Specific Custom Settings	
Modem Model	xxx Modem
IMSI	123400005678900
Network Type	3G preferred ▾
GSM Frequency Band	All Bands ▾

Modem Specific Custom Settings	
Modem Model	This field displays the Manufacturer name of the connected mobile modem.
IMSI	This field shows the IMSI number associated with the SIM inside the mobile modem.
Network Type	<p>This setting allows you to define your preference of using the 3G and/or 2G networks. 3G networks include HSPA / UMTS; 2G networks include EDGE / GPRS.</p> <p>If 3G only or 2G only is chosen, only the HSPA / UMTS or EDGE / GPRS network will be used, respectively. If the chosen network is not available, no other network will be used regardless of its availability. The modem connection will remain offline.</p> <p>If 3G preferred or 2G preferred is chosen, the chosen network will be used when it is available. If the chosen network is not available, the other network will be used whenever available.</p> <p>The default Network Type is 3G preferred.</p>
GSM Frequency Band	<p>This setting allows you to specify which GSM frequency band to be used. GSM1900 is used in United States, Canada, and many other countries in the Americas.</p> <p>GSM900 / GSM1800 / GSM2100 are used in Europe, Middle East, Africa, Asia, Oceania, and Brazil.</p> <p>If All Bands is chosen, the appropriate frequency band will be used automatically. The default GSM Frequency Band is All Bands.</p>

10.2 WAN Health Check

To ensure traffic is routed to healthy WAN connections only, Peplink Balance provides the functionality to periodically check the health of each WAN connection.

The Health Check settings for each WAN connection can be independently configured via **Network > Interfaces > WAN**:

Health Check Settings	
Method	DNS Lookup
Health Check DNS Servers	Host 1: <input type="text"/> Host 2: <input type="text"/> <input checked="" type="checkbox"/> Use first two DNS servers as Health Check DNS Servers <input type="checkbox"/> Include public DNS servers
Timeout	5 second(s)
Health Check Interval	5 second(s)
Health Retries	3
Recovery Retries	3

Health Check Settings							
Method	<p>This setting specifies the health check method for the WAN connection. The value of Method can be configured as Disabled, Ping or DNS Lookup. The default method is DNS Lookup.</p> <p>For Mobile Internet connection, the value of Method can be configured as Disabled or SmartCheck.</p>						
Health Check Disabled							
<table border="1"> <thead> <tr> <th colspan="2">Health Check Settings</th> </tr> </thead> <tbody> <tr> <td colspan="2" style="text-align: center; color: red;">Note: Health check is disabled. Enable it to detect IP routing problem.</td> </tr> <tr> <td>Method</td> <td>Disabled</td> </tr> </tbody> </table>		Health Check Settings		Note: Health check is disabled. Enable it to detect IP routing problem.		Method	Disabled
Health Check Settings							
Note: Health check is disabled. Enable it to detect IP routing problem.							
Method	Disabled						
<p>When Disabled is chosen in the Method field, the WAN connection will always be considered as up. The connection will NOT be treated as down in the event of IP routing errors.</p>							
Health Check Method: Ping							
	<table border="1"> <tbody> <tr> <td>Method</td> <td>Ping</td> </tr> <tr> <td>Ping Hosts</td> <td>Host 1: <input type="text"/> Host 2: <input type="text"/> <input checked="" type="checkbox"/> Use first two DNS servers as Ping Hosts</td> </tr> </tbody> </table>	Method	Ping	Ping Hosts	Host 1: <input type="text"/> Host 2: <input type="text"/> <input checked="" type="checkbox"/> Use first two DNS servers as Ping Hosts		
Method	Ping						
Ping Hosts	Host 1: <input type="text"/> Host 2: <input type="text"/> <input checked="" type="checkbox"/> Use first two DNS servers as Ping Hosts						
PING Hosts	<p>This setting specifies IP addresses or host names with which connectivity is to be tested via ICMP Ping.</p> <p>If Use first two DNS servers as Ping Hosts is checked, the target PING Host will be the first DNS server for the corresponding WAN connection.</p> <p>Reliable PING hosts with a high uptime should be considered.</p> <p>By default, the first two DNS servers of the WAN connection are used as the PING Hosts.</p>						

Health Check Method: DNS Lookup

Method	?	DNS Lookup
Health Check DNS Servers	?	Host 1: <input type="text"/> Host 2: <input type="text"/> <input checked="" type="checkbox"/> Use first two DNS servers as Health Check DNS Servers <input type="checkbox"/> Include public DNS servers

DNS lookups will be issued to test the connectivity with target DNS servers. The connection will be treated as up if DNS responses are received from either one or both of the servers, regardless of whether the result was positive or negative.

Health Check DNS Servers

This field allows you to specify two DNS hosts' IP address with which connectivity is to be tested via DNS Lookup.

If **Use first two DNS servers as Health Check DNS Servers** is checked, the target DNS hosts will be the first two DNS servers assigned to this WAN connection.

Reliable targets with a high uptime should be considered.

Checked the box **Include public DNS servers** to include public DNS server as target DNS hosts.

By default, the first two DNS servers of the WAN connection are used as the Health Check DNS Servers.

Health Check Method: SmartCheck

Health Check Settings		
Method	?	SmartCheck

SmartCheck applies only to the Peplink Balance 20/30/380 or above Mobile Internet connection. It monitors the link status, and is optimized for mobile networks with high traffic latency.

Other Health Check Settings

Timeout	?	5	second(s)
Health Check Interval	?	5	second(s)
Health Retries	?	3	
Recovery Retries	?	3	

Timeout

This setting specifies the timeout, in seconds, for ping/DNS lookup requests. Default Timeout is set to **5 seconds**.

Health Check Interval

This setting specifies the time interval, in seconds, between ping or DNS lookup requests. Default Health Check Interval is **5 seconds**.

Health Check Retries

This setting specifies the number of consecutive ping/DNS lookup timeouts after which Peplink Balance is to treat the corresponding WAN connection as down. Default Health Retries is set to **3**.

For example, with the default Health Retries setting of 3, after consecutive 3 timeouts, the corresponding WAN connection will be treated as down.

Recovery Retries

This setting specifies the number of consecutive successful ping/DNS lookup responses that must be received before Peplink Balance treats a previously down WAN connection to be up again.

By default, Recover Times is set to **3**. For example, a WAN connection that is treated as down will be considered to be up again upon receiving 3 consecutive successful ping/DNS lookup responses.

Note

In case a WAN connection goes down, all of the WAN connections with non-Always-on Connection Type will also be brought up until any one of higher priority WAN connections is up and found to be healthy. This design could increase the overall network availability.

For example, if WAN1, WAN2 and WAN3 have the connection types of Always-on, Backup Priority Group 1 and Backup Priority Group 2 respectively, when WAN1 goes down, WAN2 and WAN3 will also try to connect. If WAN3 is connected first, WAN2 will still be kept connecting. If WAN2 is connected, WAN3 will disconnect or abort making connection.

Automatic Public DNS Server Check on DNS Test Failure

In case the health check method is set to DNS Lookup and checks failed, the Balance will automatically perform DNS lookups on some public DNS servers. If the tests are success, it means the WAN may not be down but rather the target DNS server became malfunctioned. You will see the following warning message on the Main page.

 **Failed to receive DNS response from the health-check DNS servers for WAN connection 3. But public DNS server lookup test via the WAN passed. So please check the DNS server settings.**

10.3 Bandwidth Allowance Monitor

Bandwidth Allowance Monitor helps keep track of your network usage. Please refer to section 19.8 to view the usage statistics.

Bandwidth Allowance Monitor Settings	
Bandwidth Allowance Monitor	<input checked="" type="checkbox"/> Enable
Action	<input type="checkbox"/> Email notification is currently disabled. You can get notified when usage hits 75%/95% of monthly allowance by enabling Email Notification . <input checked="" type="checkbox"/> Disconnect when usage hits 100% of monthly allowance
Start Day	On 1st of each month at 00:00 midnight
Monthly Allowance	100 GB

Bandwidth Allowance Monitor	
Action	<p>If the feature Email Notification is enabled, you will be notified through email when usage hits 75% and 95% of the monthly allowance.</p> <p>If the box Disconnect when usage hits 100% of monthly allowance is checked, this WAN connection will be disconnected automatically when the usage hits the monthly allowance. It will not resume connection unless this option has been turned off or the usage has been reset when a new billing cycle starts.</p>
Start Day	This option allows you to define which day in the month each billing cycle begins.
Monthly Allowance	This field is for defining the maximum bandwidth usage allowed for the WAN connection each month.

10.4 Additional Public IP Settings

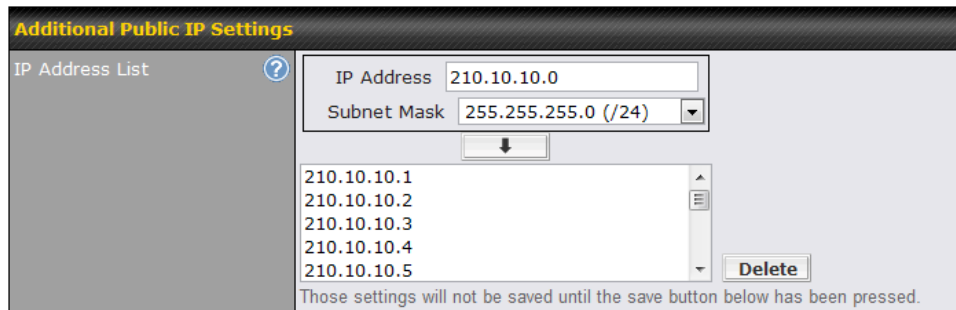

Additional Public IP Settings

IP Address List ?

IP Address

Subnet Mask

↓

210.10.10.1
210.10.10.2
210.10.10.3
210.10.10.4
210.10.10.5

Delete

Those settings will not be saved until the save button below has been pressed.

Additional Public IP Settings

IP Address List

The IP Address List represents the list of fixed Internet IP addresses assigned by the ISP, in the event that more than one Internet IP addresses are assigned to this WAN connection. Enter the fixed Internet IP addresses and the corresponding subnet mask, and then click the **Down Arrow** button to populate IP address entries to the IP Address List.

10.5 Dynamic DNS Settings

Peplink Balance provides the functionality to register the domain name relationships to dynamic DNS service providers. Through registration with dynamic DNS service provider(s), the default public Internet IP address of each WAN connection can be associated with a host name. With Dynamic DNS service enabled for a WAN connection, you can connect to your WAN's IP address from the external even if its IP address is dynamic. You have to register for an account from the listed dynamic DNS service providers before enabling this option.

If the WAN connection's IP address is a reserved private IP address (i.e. behind a NAT router), the Public IP of each WAN will be automatically reported to the DNS service provider.

Either upon a change in IP address or every 23 days without link reconnection, Peplink Balance will connect to the dynamic DNS service provider to perform an IP address update within the provider's records.

The settings for dynamic DNS service provider(s) and the association of host name(s) are configured via **Network > Interfaces > WAN**:

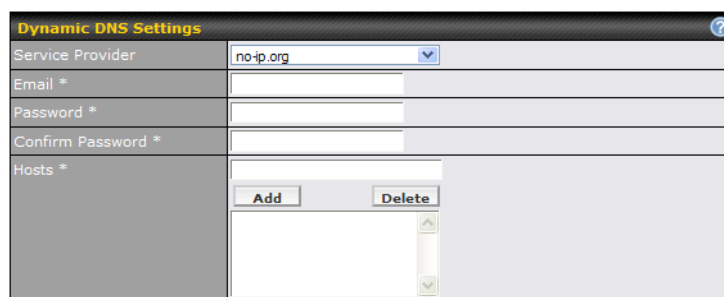

Dynamic DNS Settings	
Service Provider	This setting specifies the dynamic DNS service provider to be used for the WAN based on supported dynamic DNS service providers: <ul style="list-style-type: none"> • changeip.com • dyndns.org • no-ip.org • tzo.com Select Disabled to disable this feature.
User ID / User / Email	This setting specifies the registered user name for the dynamic DNS service.
Password / Pass / TZO Key	This setting specifies the password for the dynamic DNS service.
Hosts / Domain	This setting specifies a list of host names or domains to be associated with the public Internet IP address of the WAN connection.

Important Note

In order to use dynamic DNS services, appropriate host name registration(s), as well as a valid account with a supported dynamic DNS service provider are required.

A dynamic DNS update is performed whenever a WAN's IP address changed. E.g. IP is changed after a DHCP IP refresh, reconnection, etc.

Due to dynamic DNS service providers' policy, a dynamic DNS host would expire automatically because the host record was not updated for a long time. Therefore Peplink Balance performs an update every 23 days even if a WAN's IP address did not change.

11 Site-to-Site VPN

(This section applies only to Peplink Balance 210 or above.)



Peplink Balance Site-to-Site VPN functionality securely connects one or more branch offices to your company's main headquarters or to other branches. The data, voice, or video communications between these locations are kept confidential across the public Internet.

The Site-to-Site VPN of the Peplink Balance is specifically designed for multi-WAN environment. The Peplink Balance can aggregate all WAN connections' bandwidth for routing Site-to-Site VPN traffic. Unless all the WAN connections of one site are down, the Peplink Balance can still maintain VPN up and running.

VPN Bandwidth Bonding is supported in firmware 5.0+. All available bandwidth will be utilized to establish the VPN tunnel, and all traffic will be load balanced at packet level across all links. VPN Bandwidth Bonding is enabled by default.

Tip

You can define firewall rules to control access within the VPN network.

11.1 Site-to-Site VPN Settings

Peplink Balance 380, 390, 580, 710 and 1350 support making multiple Site-to-Site VPN connections with a remote Peplink Balance 210, 310, 380, 390, 580, 710, 1350, or a Pepwave MAX Mobile Router. Peplink Balance 210 and 310 support making two Site-to-Site VPN connections with a remote Peplink Balance 210, 310, 380, 390, 580, 710, 1350, or a Pepwave MAX Mobile Router.

Peplink Balance that supports multiple VPN connections can act as a central hub which connects branch offices. For example, branch office A and branch office B make VPN connections to headquarters C, both branch offices' LAN subnet and subnets behind it (i.e. static routes) will also be advertised to the headquarters C and the other branches. So branch office A will be able to access branch office B via headquarters C in this case.

The local LAN subnet and subnets behind the LAN (defined under **Static Route** in the LAN settings page) will be advertised to the VPN. All VPN members (branch offices and headquarters) will be able to route to the local subnets.

Note that all LAN subnet and subnets behind it have to be unique. Otherwise, VPN members will not be able to access each other.

All data can be routed over the VPN with 256-bit AES encryption standard.

To configure, navigate to **Network > Site-to-Site VPN:**

VPN Connection	Peer Serial Number	Peer Address(es)	
Branch A	1824-1234-ABCD	192.168.50.11 192.168.50.12	Delete
Branch B	1824-ABCD-1234	10.10.10.151 10.10.10.152 10.10.10.153	Delete
Add VPN Connection			

Link Failure Detection	
Link Failure Detection Time ?	<input checked="" type="radio"/> Recommended (Approx. 15 secs) <input type="radio"/> Fast (Approx. 6 secs) <input type="radio"/> Faster (Approx. 2 secs) <input type="radio"/> Extreme (Under 1 sec)
Shorter detection time incurs more health checks and higher bandwidth overhead	
Save	

A list of defined **VPN Connection** profiles and **Link Failure Detection Time** option will be shown. Click the **Add VPN Connection** button to create a new VPN connection profile for making VPN connection to a remote Peplink Balance via the available WAN connections. Each profile is for making VPN connection with one remote Peplink Balance. Click a connection name on the leftmost column to edit the profile.

VPN Settings	
VPN Connection Name ?	Headquarters
Active	<input checked="" type="checkbox"/>
Encryption ?	<input checked="" type="radio"/> 256-bit AES <input type="radio"/> Off
Peer Serial Number ?	1824-1234-1234 <input type="checkbox"/> Remote client is set up in high availability mode.
Peer IP Addresses / Host Names (Optional) ?	 If this field is empty, this field on the peer site must be filled
Route Internet Traffic to This Peer ?	<input type="checkbox"/> DNS server 1: <input type="text"/> DNS server 2: <input type="text"/>

VPN Settings	
VPN Connection Name	This field is for specifying a name to represent this VPN connection profile.
Active	When this box is checked, this VPN connection profile will be enabled. Otherwise, it will be disabled.
Encryption	By default, VPN traffic is encrypted with 256-bit AES standard. If the option Off is selected on both sides of a VPN connection, no encryption will be applied.
Peer Serial Number	Peplink Balance only establishes VPN connection with a remote peer that has a serial number specified here. If the remote peer is in high availability setup, you can check the box Remote client is set up in high availability mode and enter the second unit's serial number into the second text box.
Peer IP Addresses / Host Names (Optional)	Enter the remote peer's WAN IP address(es) or host name(s) here. Dynamic-DNS host names are accepted. This field is optional. With this field filled, the Peplink Balance will initiate connection to each of the remote IP addresses until success. If the field is empty, the Peplink Balance will wait for connection from the remote peer. Therefore, at least one side of the two VPN peers has to have this field filled. Otherwise, VPN connection cannot be established. Enter one IP address or host name per line.
Route Internet Traffic to This Peer	When this option is enabled, all Internet traffic will be routed to this VPN connection. i.e. This VPN connection will act as the "default route". DNS servers must be entered, and DNS requests will be routed to the remote peer. The remote peer will then route the Internet traffic to its first available WAN connection. This option can be enabled on one VPN connection profile only.

WAN Connection Priority

WAN Connection Priority

You can specify the priority of the WAN connections to be used in making VPN connections. A WAN connection will never be used when **OFF** is selected. Only available WAN connections with the highest priority will be utilized.

Link Failure Detection

Link Failure Detection Time

The bonded Site-to-Site VPN can detect routing failures on the path between two sites over each WAN connection. Failed WAN connections will not be used to route VPN traffic. Health check packets are sent to the peer to detect any failure. The more frequent checks it sends, the shorter detection time, but the higher bandwidth overhead will be consumed.

When **Recommended** is selected, a health check packet is sent out every 5 seconds, and the expected detection time is 15 seconds.

When **Fast** is selected, a health check packet is sent out every 3 seconds, and the expected detection time is 6 seconds.

When **Faster** is selected, a health check packet is sent out every 1 second, and the expected detection time is 2 seconds.

When **Extreme** is selected, a health check packet is sent out every 0.1 second, and the expected detection time is under 1 second.

By default, **Recommended** is selected.

Important Note to Users Upgrading to Firmware 5.0+

The Site-to-Site VPN in firmware 5.0+ requires the same firmware version for all devices in the VPN network. Please make sure that both ends of the Peplink Balance units are running with the same firmware version.

Important Note

- When outbound Internet traffic is routed to remote Site-to-Site VPN peer, the remote peer will route the traffic to its first available WAN connection only.
- Peplink proprietary Site-to-Site VPN used TCP port 32015, IP Protocol 47 and IP Protocol 99 for establishing VPN connections. If you have a firewall in front of the Peplink Balance devices, you will need to add firewall rules for these port and protocols which will allow inbound and outbound traffic pass-through the firewall.

Tip

Want to know more about VPN Sub-Second Session Failover? Visit our [YouTube Channel](http://www.youtube.com/PeplinkChannel#p/u/0/FXPAJ37b4pQ) for a video tutorial!

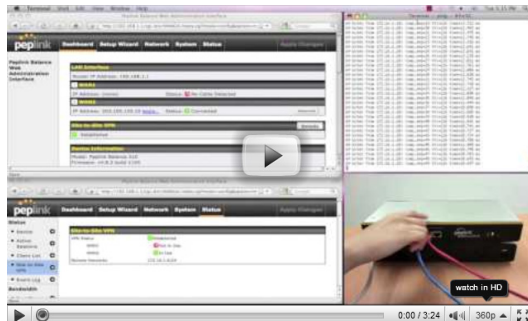

<http://www.youtube.com/PeplinkChannel#p/u/0/FXPAJ37b4pQ>

11.2 Peplink Balance Behind NAT Router

The Peplink Balance supports establishing Site-to-Site VPN over WAN connections which are behind a NAT (Network Address Translation) router.

To be able for a WAN connection behind a NAT router to accept VPN connections, you can configure the NAT router in front of the WAN connection to inbound port forward TCP port 32015 to the Peplink Balance.

If one or more WAN connections on **Unit A** can accept VPN connections (by means of port forwarding or not) while none of the WAN connections on the peer **Unit B** can do so, you should put all public IP addresses or host names of the **Unit A** to the **Unit B's Peer IP Addresses / Host Names** field. Leave the field in **Unit A** blank. With such setting, site-to-site VPN connection can be set up and all WAN connections on both sides will be utilized.

For example, see the following diagram:

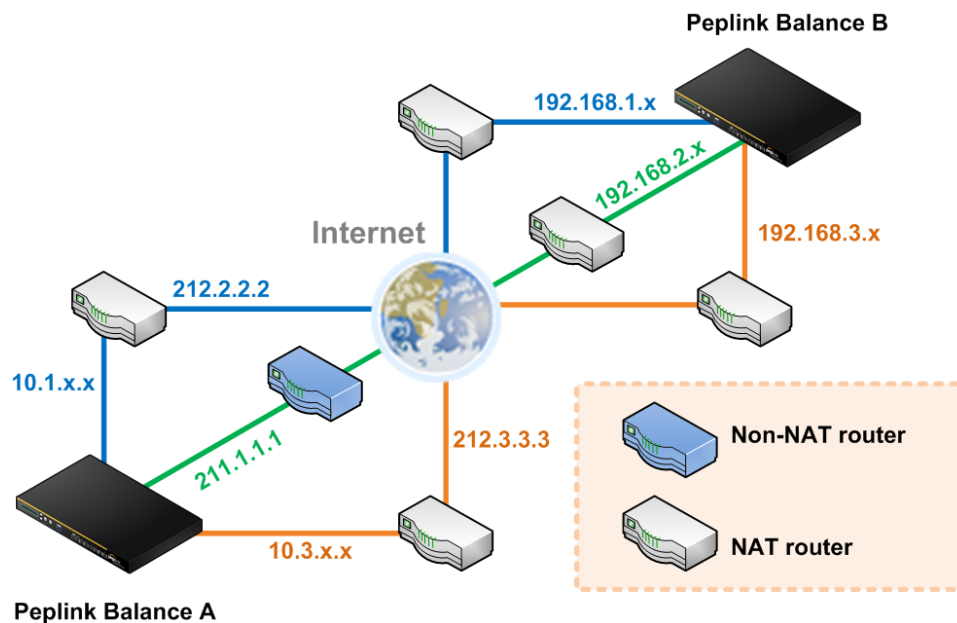

One of the WANs of Balance A is non-NAT'd (212.1.1.1). The rest of the WANs on Balance A and all WANs on Balance B are NAT'd. In such case, the **Peer IP Addresses / Host Names** field in Balance B should be filled with all of the Balance A's host names or public IP addresses (i.e. 212.1.1.1, 212.2.2.2 and 212.3.3.3), and the field in Balance A can be left blank. The two NAT routers on WAN1 and WAN3 of Balance A should inbound port forward TCP port 32015 to the Balance A so that all WANs would be utilized to establish VPN.

11.3 VPN Status

VPN Status is shown in the **Dashboard**. The connection status of each connection profile is shown as below.

Site-to-Site VPN		Details
Branch A	 Established	
Branch B	 Connecting...	

VPN connection status is also shown on the LCD panel of Peplink Balance 380, 390, 580, 710 and 1350. By clicking the **Details** button at the top-right hand corner of Site-to-Site VPN table, you will be forwarded to **Status > Site-to-Site VPN**. You can view the subnet and WAN connection information of each VPN peer. Please refer to section 19.5 for details.

IP subnets must be unique among VPN peers

The entire inter-connected Site-to-Site VPN network is one single non-NAT IP network. No two subnets in two sites shall be duplicated. Otherwise, connectivity problems will be experienced in accessing those subnets.

12 Management of Outbound Traffic to WAN

Peplink Balance provides the functionality to flexibly manage and load balance outbound traffic among the WAN connections.

Important Note

Outbound Policy is applied only when more than one WAN connection is active.

The settings for managing and load balancing outbound traffic are located in **Network > Outbound Policy**:

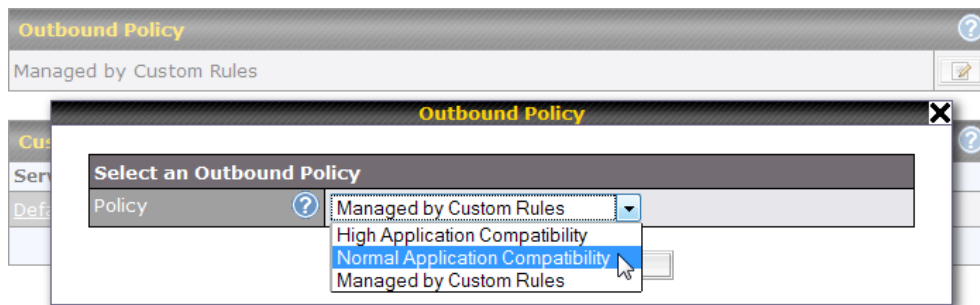

12.1 Outbound Policy

There are three main selections for the Outbound Traffic Policy of Peplink Balance:

- High Application Compatibility
- Normal Application Compatibility
- Managed by Custom Rules

The selections are explained as follows:

Outbound Policy Settings	
High Application Compatibility	With the selection of this policy, outbound traffic from a source LAN device is routed through the same WAN connection regardless of the destination Internet IP address and protocol. This provides the highest application compatibility.
Normal Application Compatibility	With the selection of this policy, outbound traffic from a source LAN device to the same destination Internet IP address will persistently be routed through the same WAN connection regardless of protocol. This provides high compatibility to most applications, and users still benefit from WAN link load balancing when multiple Internet servers are accessed.
Managed by Custom Rules	With the selection of this policy, outbound traffic behavior can be managed by defining custom rules. Rules can be defined in a custom rule table. A default rule can be defined for connections that cannot be matched with any one of the rules.

The default policy is **Normal Application Compatibility**.

Tip

Want to know more about how-to create outbound rules? Visit our [YouTube Channel](#) for a video tutorial!

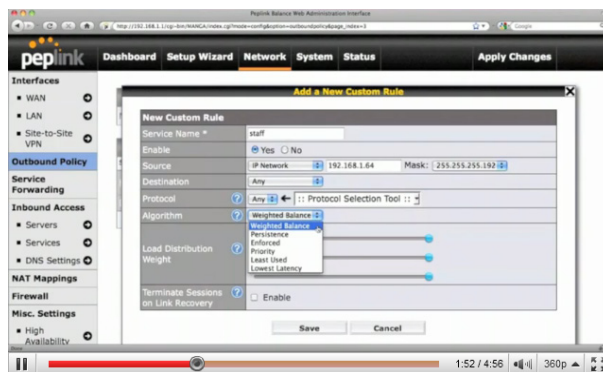

http://www.youtube.com/PeplinkChannel#p/u/2/m977ePdM_sl

12.2 Custom Rules For Outbound Policy

Click  in the Outbound Policy form. Choose **Managed by Custom Rules** and press the **Save** button. The following screen will then be displayed.



Service	Algorithm	Source	Destination	Protocol / Port
HTTPS_Persis...	Persistence (Src) (Auto)	Any	Any	TCP 443
Default	(Auto)			

The bottom-most rule is **Default**. Edit this rule to change the device's default way to control outbound traffic for all connections that does not match any rules above it. Click on the service name **Default** to change its settings.

You may drag and drop a row to rearrange the priority of outbound rules.

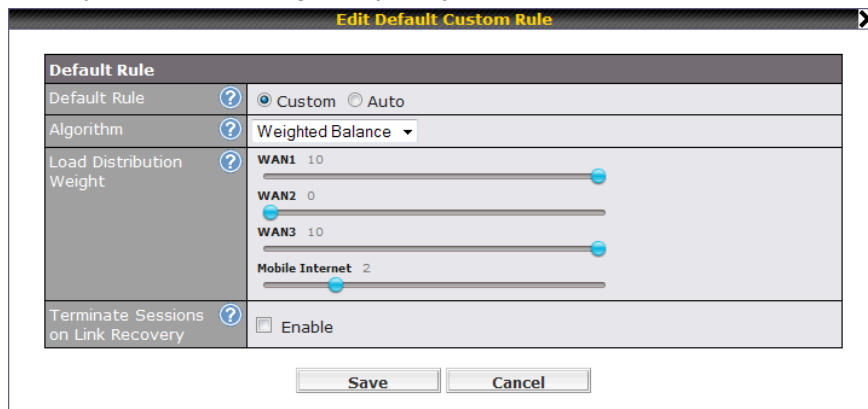

By default, **Auto** is selected for the option **Default Rule**. You can select **Custom** in order to change the Algorithm to be used. Please refer to the upcoming sections for the details of the available algorithms.

To create a custom rule, click **Add Rule** at the bottom of the table, and the following window will be displayed:

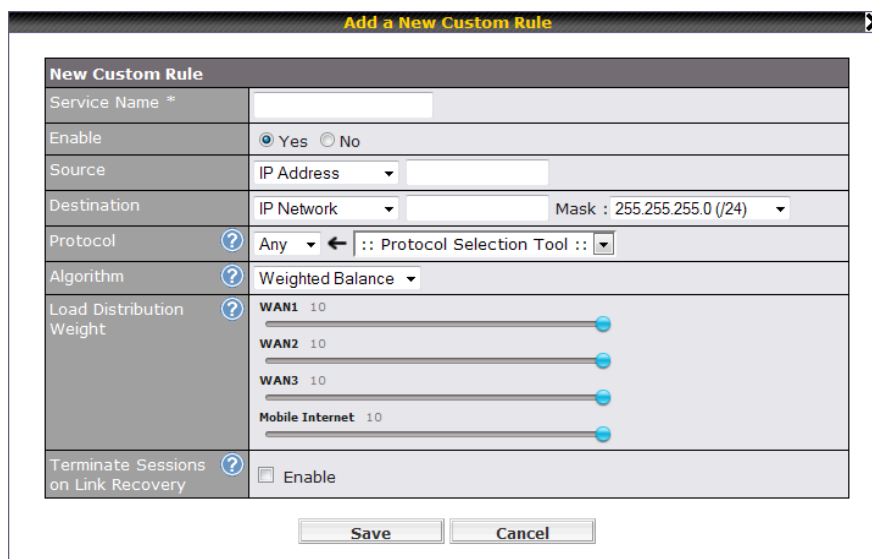

New Custom Rule Settings	
Service Name	This setting specifies the name of the outbound traffic rule.
Enable	<p>This setting specifies whether the outbound traffic rule takes effect.</p> <p>With an Enable value of Yes, the rule takes effect: traffic is matched, and actions are taken, by Peplink Balance based on the other parameters of the rule.</p> <p>With an Enable value of No, the rule does not take effect: Peplink Balance disregards the other parameters of the rule.</p>
Source	This setting specifies the source IP Address, IP Network or MAC Address for traffic that matches the rule.
Destination	This setting specifies the destination IP Address or IP Network for traffic that matches the rule.
Protocol and Port	This setting specifies the IP Protocol and Port of traffic that matches this rule. You may select some common protocol from the Protocol Selection Tool drop-down menu.
Algorithm	<p>This setting specifies the behavior of Peplink Balance for the custom rule.</p> <p>One of the following values can be selected:</p> <ul style="list-style-type: none"> • Weighted Balance • Persistence • Enforced • Priority • Overflow • Least Used (not applicable to Balance 20/30) • Lowest Latency (not applicable to Balance 20/30) <p>The upcoming sections present the details of the listed algorithms.</p>
Terminate Sessions on Link Recovery	<p>This setting specifies whether to terminate existing IP sessions on a less preferred WAN connection in the event that a more preferred WAN connection is recovered. This setting is applicable to the Algorithms: Weighted, Persistence and Priority.</p> <p>By default, this is disabled. In this case, all existing IP sessions will not be terminated or affected when any other WAN connection is recovered. If it is set to enabled, existing IP sessions may be terminated when another WAN connection is recovered such that only the preferred healthy WAN connection(s) are used at any point in time.</p>

12.2.1 Algorithm: Weighted Balance

This setting specifies the ratio of WAN connection usage to be applied on the specified IP Protocol & Port, and is applicable only when Algorithm is set to **Weighted Balance**.

Algorithm	<input type="text" value="Weighted Balance"/>												
Load Distribution Weight	<table> <tr> <td>WAN1</td> <td>10</td> <td><input type="range" value="10"/></td> </tr> <tr> <td>WAN2</td> <td>10</td> <td><input type="range" value="10"/></td> </tr> <tr> <td>WAN3</td> <td>10</td> <td><input type="range" value="10"/></td> </tr> <tr> <td>Mobile Internet</td> <td>10</td> <td><input type="range" value="10"/></td> </tr> </table>	WAN1	10	<input type="range" value="10"/>	WAN2	10	<input type="range" value="10"/>	WAN3	10	<input type="range" value="10"/>	Mobile Internet	10	<input type="range" value="10"/>
WAN1	10	<input type="range" value="10"/>											
WAN2	10	<input type="range" value="10"/>											
WAN3	10	<input type="range" value="10"/>											
Mobile Internet	10	<input type="range" value="10"/>											

The amount of matching traffic that is distributed to a WAN connection is proportional to the weight of WAN connection relative to the total weight. Use the sliders to change each WAN's weight.

Example: With the following weight settings on a Peplink Balance 310:

- WAN1: 10
- WAN2: 10
- WAN3: 5

Total weight is 25 = (10 + 10 + 5)

Matching traffic distributed to WAN1 is 40% = (10 / 25) x 100%

Matching traffic distributed to WAN2 is 40% = (10 / 25) x 100%

Matching traffic distributed to WAN3 is 20% = (5 / 25) x 100%

12.2.2 Algorithm: Persistence

The configuration of Persistent Services is the solution to the few situations where link load distribution for Internet services is undesirable.

For example, many e-banking and other secure websites, for security reasons, terminate the session when the client computer's Internet IP address changes mid-session.

In general, different Internet IP addresses represent different computers. The security concern is that an IP address change during a session may be the result of an unauthorized intrusion attempt. Therefore, to prevent damages from the potential intrusion, the session is terminated upon the detection of an IP address change.

Peplink Balance can be configured to distribute data traffic across multiple WAN connections. Also, the Internet IP depends on the WAN connections over which communication actually takes place. As a result, a LAN client computer behind Peplink Balance may communicate using multiple Internet IP addresses. For example, a LAN client computer behind a Peplink Balance 310 with three WAN connections may communicate on the Internet using three different IP addresses.

With the Persistency feature of Peplink Balance, rules can be configured to enable client computers to persistently utilize the same WAN connections for e-banking and other secure websites. As a result, a client computer will communicate using one IP address and eliminate the issues.

Algorithm	<input type="text" value="Persistence"/>												
Persistence Mode	<input type="radio"/> By Source <input checked="" type="radio"/> By Destination												
Load Distribution	<input type="radio"/> Auto <input checked="" type="radio"/> Custom												
Load Distribution Weight	<table> <tr> <td>WAN1</td> <td>10</td> <td><input type="range" value="10"/></td> </tr> <tr> <td>WAN2</td> <td>10</td> <td><input type="range" value="10"/></td> </tr> <tr> <td>WAN3</td> <td>10</td> <td><input type="range" value="10"/></td> </tr> <tr> <td>Mobile Internet</td> <td>10</td> <td><input type="range" value="10"/></td> </tr> </table>	WAN1	10	<input type="range" value="10"/>	WAN2	10	<input type="range" value="10"/>	WAN3	10	<input type="range" value="10"/>	Mobile Internet	10	<input type="range" value="10"/>
WAN1	10	<input type="range" value="10"/>											
WAN2	10	<input type="range" value="10"/>											
WAN3	10	<input type="range" value="10"/>											
Mobile Internet	10	<input type="range" value="10"/>											

There are two Persistent Modes. One is **by source** and the other **by destination**.

By Source: The same WAN connection will be used for traffic matching the rule and originating from the same machine regardless of its destination. This option will provide the highest level of application compatibility.

By Destination: The same WAN connection will be used for traffic matching the rule, originating from the same machine, and going to the same destination. This option can better distribute load to WAN connections when there are only a few client machines.

The default Mode is **By Source**.

When there are multiple client requests, they can be distributed (persistently) to WAN connections with a weight. If you choose **Auto** in **Load Distribution**, the weights will be automatically adjusted according to each WAN's **Download Bandwidth** which is specified in the WAN settings page (see Section 10 Configuration of WAN Interface(s)). If you choose **Custom**, you can customize the weight of each WAN manually by using the sliders.

12.2.3 Algorithm: Enforced

This setting specifies the WAN connection usage to be applied on the specified IP Protocol & Port, and is applicable only when the Algorithm is set to **Enforced**.

Algorithm ?	Enforced
Enforced Connection ?	WAN1

Matching traffic will be routed through the specified WAN connection regardless of health check status of the WAN connection.

12.2.4 Algorithm: Priority

This setting specifies the priority of the WAN connections to be utilized to route the specified network service. The highest priority WAN connection available will always be used for routing the specified type of traffic. A lower priority WAN connection will be used only when all higher priority connections have become unavailable.

Algorithm ?	Priority						
Priority Order ?	<table border="1"><tr><td>Highest Priority</td></tr><tr><td>WAN1</td></tr><tr><td>WAN2</td></tr><tr><td>WAN3</td></tr><tr><td>Mobile Internet</td></tr><tr><td>Lowest Priority</td></tr></table>	Highest Priority	WAN1	WAN2	WAN3	Mobile Internet	Lowest Priority
Highest Priority							
WAN1							
WAN2							
WAN3							
Mobile Internet							
Lowest Priority							

Tip

Configure multiple distribution rules to accommodate different kinds of services.

12.2.5 Algorithm: Overflow

The traffic matching this rule will be routed through the healthy WAN connection that has the highest priority and is not in full load. When this connection gets saturated, new sessions will be routed to the next healthy WAN connection that is not in full load.

Algorithm	Overflow						
Overflow Order	<table border="1"> <tr><td>Highest Priority</td></tr> <tr><td>WAN1</td></tr> <tr><td>WAN2</td></tr> <tr><td>WAN3</td></tr> <tr><td>Mobile Internet</td></tr> <tr><td>Lowest Priority</td></tr> </table>	Highest Priority	WAN1	WAN2	WAN3	Mobile Internet	Lowest Priority
Highest Priority							
WAN1							
WAN2							
WAN3							
Mobile Internet							
Lowest Priority							

Drag and drop to specify the order of WAN connections to be used for routing traffic. Only the highest priority healthy connection that is not in full load will be utilized.

12.2.6 Algorithm: Least Used

(This section applies only to Peplink Balance 210 or above)

Algorithm	LeastUsed
Connection	<input checked="" type="checkbox"/> WAN1 <input checked="" type="checkbox"/> WAN2 <input checked="" type="checkbox"/> WAN3 <input checked="" type="checkbox"/> Mobile Internet

The traffic matching this rule will be routed through the healthy WAN connection that is selected in the field **Connection** and has the most available download bandwidth. The available download bandwidth of a WAN connection is calculated from the total download bandwidth specified in the WAN settings page and the current download usage. The available bandwidth and WAN selection is determined every time when an IP session is made.

12.2.7 Algorithm: Lowest Latency

(This section applies only to Peplink Balance 210 or above)

Algorithm	Lowest Latency <small>Note: Use of Lowest Latency will incur additional network usage.</small>
Connection	<input checked="" type="checkbox"/> WAN1 <input checked="" type="checkbox"/> WAN2 <input checked="" type="checkbox"/> WAN3 <input checked="" type="checkbox"/> Mobile Internet

The traffic matching this rule will be routed through the healthy WAN connection that is selected in the field *Connection* and has the lowest latency. Latency checking packets are issued periodically to a nearby router of each WAN connection to determine its latency value. The latency of a WAN is the packet round trip time of the WAN connection. Additional network usage may be incurred as a result.

Tip

The round trip time of a “6M down / 640k up” link can be higher than that of a “2M down / 2M up” link. It is because the overall round trip time is lengthened by its slower upload bandwidth despite of its higher downlink speed. Therefore this algorithm is good for two scenarios:

- All WAN connections are symmetric; or
- A latency sensitive application requires to be routed through the lowest latency WAN regardless the WAN's available bandwidth.

13 Inbound Access

Inbound Access is also known as inbound port address translation. On NAT WAN connection, all inbound traffic to the server behind Peplink unit requires Inbound Access rules.

By the custom definition of servers and services for inbound access, Internet users can access the servers behind Peplink Balance. Advanced configurations allow inbound access to be distributed among multiple servers on the LAN.

Important Note

Inbound Access applies only to WAN connections that operate under NAT mode. For WAN connections that operate under drop-in mode or IP forwarding, inbound traffic is forwarded to the LAN by default.

13.1 Definition of Port Forwarding

(This section applies only to Peplink Balance 20 and 30.)

Inbound Port Forwarding rules are defined at: **Network > Inbound Access > Port Forwarding**

Service	IP Address(es)	Server	Protocol	Action
Web	WAN1: default	192.168.1.10	TCP:80	Delete
Add Service				

To define a new service, click the **Add Service** button, upon which the following appears:

Enable	<input checked="" type="radio"/> Yes <input type="radio"/> No																												
Service Name *	Web																												
IP Protocol	TCP ← HTTP																												
Port	Single Port Service Port: 80																												
Inbound IP Address(es) * (Require at least one IP address)	<table border="1"> <thead> <tr> <th colspan="2">Connection / IP Address(es)</th> <th>All</th> <th>Clear</th> </tr> </thead> <tbody> <tr> <td><input checked="" type="checkbox"/> WAN1</td> <td><input checked="" type="checkbox"/> 218.100.66.100 (Interface IP)</td> <td><input type="checkbox"/></td> <td><input type="checkbox"/></td> </tr> <tr> <td></td> <td><input type="checkbox"/> 218.100.66.66</td> <td><input type="checkbox"/></td> <td><input type="checkbox"/></td> </tr> <tr> <td></td> <td><input type="checkbox"/> 218.100.66.103</td> <td><input type="checkbox"/></td> <td><input type="checkbox"/></td> </tr> <tr> <td><input type="checkbox"/> WAN2</td> <td></td> <td><input type="checkbox"/></td> <td><input type="checkbox"/></td> </tr> <tr> <td><input type="checkbox"/> WAN3</td> <td></td> <td><input type="checkbox"/></td> <td><input type="checkbox"/></td> </tr> <tr> <td><input type="checkbox"/> Mobile Internet</td> <td></td> <td><input type="checkbox"/></td> <td><input type="checkbox"/></td> </tr> </tbody> </table>	Connection / IP Address(es)		All	Clear	<input checked="" type="checkbox"/> WAN1	<input checked="" type="checkbox"/> 218.100.66.100 (Interface IP)	<input type="checkbox"/>	<input type="checkbox"/>		<input type="checkbox"/> 218.100.66.66	<input type="checkbox"/>	<input type="checkbox"/>		<input type="checkbox"/> 218.100.66.103	<input type="checkbox"/>	<input type="checkbox"/>	<input type="checkbox"/> WAN2		<input type="checkbox"/>	<input type="checkbox"/>	<input type="checkbox"/> WAN3		<input type="checkbox"/>	<input type="checkbox"/>	<input type="checkbox"/> Mobile Internet		<input type="checkbox"/>	<input type="checkbox"/>
Connection / IP Address(es)		All	Clear																										
<input checked="" type="checkbox"/> WAN1	<input checked="" type="checkbox"/> 218.100.66.100 (Interface IP)	<input type="checkbox"/>	<input type="checkbox"/>																										
	<input type="checkbox"/> 218.100.66.66	<input type="checkbox"/>	<input type="checkbox"/>																										
	<input type="checkbox"/> 218.100.66.103	<input type="checkbox"/>	<input type="checkbox"/>																										
<input type="checkbox"/> WAN2		<input type="checkbox"/>	<input type="checkbox"/>																										
<input type="checkbox"/> WAN3		<input type="checkbox"/>	<input type="checkbox"/>																										
<input type="checkbox"/> Mobile Internet		<input type="checkbox"/>	<input type="checkbox"/>																										
Server IP Address	192.168.1.10																												

* Required Fields

Save Cancel

Port Forwarding Settings

Enable

This setting specifies whether the Inbound Service takes effect. With an Enable value of **Yes**, the inbound service takes effect: traffic is matched, and actions are taken, by Peplink Balance based on the other parameters of the rule. With an Enable value of **No**, the inbound service does not take effect: Peplink Balance disregards the other parameters of the rule.

Service Name

This setting identifies the service to the System Administrator. Valid values for this setting consist only of alphanumeric and the underscore “_” characters.

IP Protocol

The IP Protocol setting, along with the Port setting, specifies the protocol of the service as TCP, UDP, ICMP or IP.

Traffic that is received by Peplink Balance via the specified protocol at the specified port(s) is forwarded to the LAN hosts specified by the Servers setting.

(Please refer below for details on the Port and Servers settings.)

Alternatively, the **Protocol Selection Tool** drop-down menu can be used to automatically fill in the Protocol and a single Port number of common Internet services (e.g. HTTP, HTTPS, etc.) After selecting an item from the **Protocol Selection Tool** drop-down menu, the Protocol and Port number remains manually modifiable.

Port

The Port setting specifies the port(s) that correspond to the service, and can be configured to behave in one of the following manners:

Any Port, Single Port, Port Range, Port Map and Range Mapping

Port ? Any Port ▼

Any Port: all traffic that is received by Peplink Balance via the specified protocol is forwarded to the servers specified by the Servers setting.

For example, with IP Protocol set to **TCP**, and Port set to **Any Port**, all TCP traffic is forwarded to the configured servers.

Port ? Single Port ▼ Service Port:

Single Port: traffic that is received by Peplink Balance via the specified protocol at the specified port is forwarded via the same port to the servers specified by the Servers setting.

For example, with IP Protocol set to **TCP**, and Port set to **Single Port** and **Service Port** 80, TCP traffic received on Port 80 is forwarded to the configured servers via Port 80.

Port ? Port Range ▼ Service Ports: -

Port Range: traffic that is received by Peplink Balance via the specified protocol at the specified port range is forwarded via the same respective ports to the LAN hosts specified by the Servers setting.

For example, with IP Protocol set to **TCP**, and Port set to **Port Range** and **Service Port** 80-88, TCP traffic received on ports 80 through 88 is forwarded to the configured servers via the respective ports.

Port ? Port Mapping ▼ Service Port:
Map to Port:

Port Mapping: traffic that is received by Peplink Balance via the specified protocol at the specified port is forwarded via a different port to the servers specified by the Servers setting.

For example, with IP Protocol set to **TCP**, and Port set to **Port Mapping**, **Service Port** 80, and **Map to Port** 88, TCP traffic on Port 80 is forwarded to the configured servers via Port 88.

(Please see below for details on the Servers setting.)

Port ? Range Mapping ▼ Service Ports: -
Map to Ports: -

Range Mapping: traffic that is received by Peplink Balance via the specified protocol at the specified port range is forwarded via a different port to the servers specified by the Servers setting.

Inbound IP Address(es) This setting specifies the WAN connections and Internet IP address(es) from which the service can be accessed.

Server IP Address This setting specifies the LAN IP address of the server that handles the requests for the service.

13.2 Definition of Servers on LAN

(This section applies only to Peplink Balance 210 or above)

The settings to configure servers on the LAN are located at the following location: **Network > Inbound Access > Servers**

Server Name	IP Address	
No Servers Defined		
<input type="button" value="Add Server"/>		

To define a new server, click **Add Server**, upon which the following screen appears:

Server Name *	<input type="text" value="myserver"/>
IP Address *	<input type="text" value="192.168.1.123"/>

* Required

Enter a valid server name (should be consisted of alphanumeric and the underscore “_” characters only), and the corresponding LAN IP address.

Upon clicking **Save** after entering required information, the following screen appears.

Server Name	IP Address	
myserver	192.168.1.123	<input type="button" value="Delete"/>
<input type="button" value="Add Server"/>		

To define additional servers, click **Add Server** and repeat the above steps.

13.3 Inbound Access Services

13.3.1 Definition of Services

Services are defined at: **Network > Inbound Access > Services**

Service	IP Address(es)	Server	Protocol	Action
No Services Defined				
Add Service				

Tip

At least one server must be defined before services can be added.

To define a new service, click the **Add Service** button, upon which the following appears:

Enable	<input checked="" type="radio"/> Yes <input type="radio"/> No																					
Service Name *	web																					
IP Protocol	TCP	← HTTP																				
Port	Single Port	Service Port: 80																				
Inbound IP Address(es) * <small>(Require at least one IP address)</small>	<table border="1"> <thead> <tr> <th colspan="2">Connection / IP Address(es)</th> <th>All</th> <th>Clear</th> </tr> </thead> <tbody> <tr> <td><input checked="" type="checkbox"/> WAN1</td> <td><input checked="" type="checkbox"/> 123.123.123.1 (Interface IP)</td> <td></td> <td></td> </tr> <tr> <td><input type="checkbox"/> WAN2</td> <td></td> <td></td> <td></td> </tr> <tr> <td><input type="checkbox"/> WAN3</td> <td></td> <td></td> <td></td> </tr> <tr> <td><input type="checkbox"/> Mobile Internet</td> <td></td> <td></td> <td></td> </tr> </tbody> </table>		Connection / IP Address(es)		All	Clear	<input checked="" type="checkbox"/> WAN1	<input checked="" type="checkbox"/> 123.123.123.1 (Interface IP)			<input type="checkbox"/> WAN2				<input type="checkbox"/> WAN3				<input type="checkbox"/> Mobile Internet			
Connection / IP Address(es)		All	Clear																			
<input checked="" type="checkbox"/> WAN1	<input checked="" type="checkbox"/> 123.123.123.1 (Interface IP)																					
<input type="checkbox"/> WAN2																						
<input type="checkbox"/> WAN3																						
<input type="checkbox"/> Mobile Internet																						
Included Server(s) * <small>(Require at least one Server)</small>	<table border="1"> <thead> <tr> <th colspan="2">Server</th> <th>Weight</th> </tr> </thead> <tbody> <tr> <td><input checked="" type="checkbox"/> myserver (192.168.1.123)</td> <td></td> <td>1</td> </tr> </tbody> </table>		Server		Weight	<input checked="" type="checkbox"/> myserver (192.168.1.123)		1														
Server		Weight																				
<input checked="" type="checkbox"/> myserver (192.168.1.123)		1																				

* Required Fields

[Save](#) [Cancel](#)

Services Settings

Enable

This setting specifies whether the inbound service rule takes effect.

When **Yes** is selected, the inbound service rule takes effect. If the inbound traffic matches the specified IP Protocol and Port, action will be taken by Peplink Balance based on the other parameters of the rule.

When **No** is selected, the inbound service rule does not take effect. Peplink Balance will disregard the other parameters of the rule.

Service Name

This setting identifies the service to the System Administrator.

Valid values for this setting consist only of alphanumeric and the underscore “_” characters.

IP Protocol

The IP Protocol setting, along with the Port setting, specifies the protocol of the service as TCP, UDP, ICMP or IP.

Traffic that is received by Peplink Balance via the specified protocol at the specified port(s) is forwarded to the LAN hosts specified by the Servers setting.

(Please see below for details on the Port and Servers settings.)

Alternatively, the **Protocol Selection Tool** drop-down menu can be used to automatically fill in the Protocol and a single Port number of common Internet services (e.g. HTTP, HTTPS, etc.).

After selecting an item from the **Protocol Selection Tool** drop-down menu, the Protocol and Port number remains manually modifiable.

The Port setting specifies the port(s) that correspond to the service, and can be configured to behave in one of the following manners:

Any Port, Single Port, Port Range, Port Map and Range Mapping

Port		Any Port	<input type="button" value="v"/>
------	---	----------	----------------------------------

Any Port: all traffic that is received by Peplink Balance via the specified protocol is forwarded to the servers specified by the Servers setting.

For example, with IP Protocol set to **TCP**, and Port set to **Any Port**, all TCP traffic is forwarded to the configured servers.

Port		Single Port	<input type="button" value="v"/>	Service Port:	<input type="text"/>
------	---	-------------	----------------------------------	---------------	----------------------

Single Port: traffic that is received by Peplink Balance via the specified protocol at the specified port is forwarded via the same port to the servers specified by the Servers setting.

For example, with IP Protocol set to **TCP**, and Port set to **Single Port** and **Service Port** 80, TCP traffic received on Port 80 is forwarded to the configured servers via Port 80.

Port		Port Range	<input type="button" value="v"/>	Service Ports:	<input type="text"/> - <input type="text"/>
------	---	------------	----------------------------------	----------------	---

Port Range: traffic that is received by Peplink Balance via the specified protocol at the specified port range is forwarded via the same respective ports to the LAN hosts specified by the Servers setting.

For example, with IP Protocol set to **TCP**, and Port set to **Port Range** and **Service Port** 80-88, TCP traffic received on ports 80 through 88 is forwarded to the configured servers via the respective ports.

Port		Port Mapping	<input type="button" value="v"/>	Service Port:	<input type="text"/>
				Map to Port:	<input type="text"/>

Port Mapping: traffic that is received by Peplink Balance via the specified protocol at the specified port is forwarded via a different port to the servers specified by the Servers setting.

For example, with IP Protocol set to **TCP**, and Port set to **Port Mapping**, **Service Port** 80, and **Map to Port** 88, TCP traffic on Port 80 is forwarded to the configured servers via Port 88. (Please see below for details on the Servers setting.)

Port		Range Mapping	<input type="button" value="v"/>	Service Ports:	<input type="text"/> - <input type="text"/>
				Map to Ports:	<input type="text"/> - <input type="text"/>

Range Mapping: traffic that is received by Peplink Balance via the specified protocol at the specified port range is forwarded via a different port to the servers specified by the Servers setting.

Port

Inbound IP Address(es)

This setting specifies the WAN connections and Internet IP address(es) from which the service can be accessed.

Included Server(s)

This setting specifies the LAN servers that handle requests for the service, and the relative weight values.

The amount of traffic that is distributed to a server is proportional to the weight value assigned to the server relative to the total weight.

Example:

With the following weight settings on a Peplink Balance:

- demo_server_1: 10
- demo_server_2: 5

The total weight is 15 = (10 + 5)

Matching traffic distributed to demo_server_1: 67% = (10 / 15) x 100%

Matching traffic distributed to demo_server_2: 33% = (5 / 15) x 100%

13.4 UPnP / NAT-PMP Settings

UPnP and NAT-PMP are network protocols which allow a computer on the LAN to automatically configure the router to allow parties on the WAN to connect to itself. In this way, the process of inbound port forwarding is automated.

When a computer creates a rule using these protocols, the specified TCP/UDP port of all WAN connections' default IP address will be forwarded.

Check the corresponding box(es) to enable UPnP and/or NAT-PMP. Enable these features only if you trust the computers on the LAN.

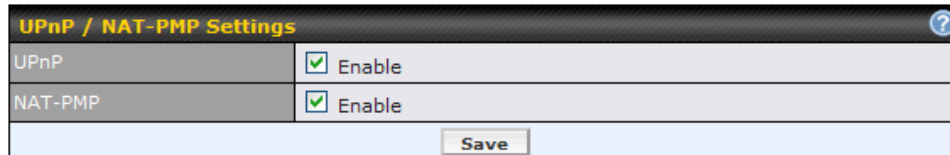

UPnP / NAT-PMP Settings	
UPnP	<input checked="" type="checkbox"/> Enable
NAT-PMP	<input checked="" type="checkbox"/> Enable
<input type="button" value="Save"/>	

When the options are enabled, a table listing all the forwarded ports under these two protocols can be found at **Status > UPnP / NAT-PMP**.

13.5 Definition of DNS Records

(This section applies only to Peplink Balance 210 or above)

The built-in DNS Server functionality of Peplink Balance facilitates inbound load balancing. With the presence of the functionality, NS/SOA DNS records for a domain name can be delegated to Internet IP address(es) of Peplink Balance. Upon receiving a DNS query, Peplink Balance supports returning, as an "A" record, the corresponding IP address for the domain name on the most appropriate healthy WAN connection. It also supports acting as a generic DNS server for hosting "A", "CNAME", "MX", "TXT" and "NS" records.

For example:

(This example is for illustration only; the actual resolution that takes place in implementation will likely be different.)

The DNS resolution of the domain name www.mycompany.com is delegated to the WAN2 Internet IP addresses of Peplink Balance.

Upon receiving the DNS query, Peplink Balance returns, as an "A" record, the IP address for www.mycompany.com on WAN1 because WAN1 is the most appropriate healthy link.

The settings for defining the DNS records to be hosted by Peplink Balance are located at: **Network > Inbound Access > DNS Settings**

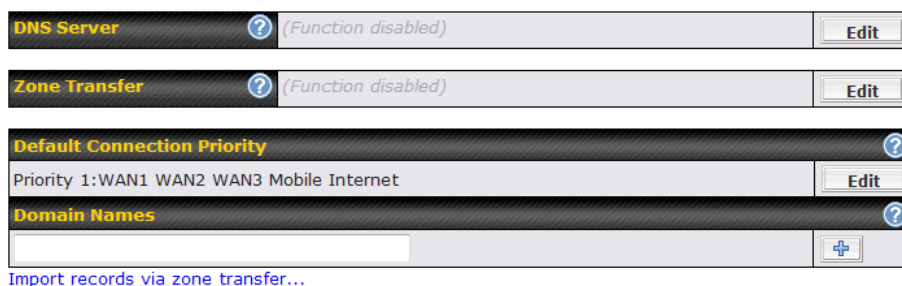

The screenshot shows the DNS Settings configuration page. It includes several sections: 'DNS Server' (Function disabled), 'Zone Transfer' (Function disabled), 'Default Connection Priority' (Priority 1: WAN1 WAN2 WAN3 Mobile Internet), and 'Domain Names'. Each section has an 'Edit' button. Below the 'Domain Names' section is a text input field and a '+' button. A link 'Import records via zone transfer...' is located below the input field.

DNS Settings

This setting specifies the WAN IP addresses on which the DNS server of Peplink Balance should listen.

If no addresses are selected, the Inbound Link Load Balancing feature will be disabled; Peplink Balance will not respond to DNS requests.

To specify and/or modify the IP addresses on which the DNS Server should listen, click the **Edit** button that corresponds to **DNS Server Listens on**, and the following screen is displayed:

DNS Server

Connection / IP Address(es)	
<input checked="" type="checkbox"/> WAN1	<input checked="" type="checkbox"/> 123.123.123.1 (Interface IP)
<input type="checkbox"/> WAN2	
<input type="checkbox"/> WAN3	
<input type="checkbox"/> Mobile Internet	

To specify the Internet IP addresses on which the DNS Server should listen, select the WAN connection by checking the appropriate boxes and the IP addresses associated with the WAN connections by highlighting the appropriate items in the list. (Multiple items in the list can be selected by holding CTRL and clicking on the items.)

Click **Save** to save the settings when configuration is complete.

Zone Transfer

This setting specifies the IP address(es) of secondary DNS server(s) that are to be allowed to retrieve zone records from the DNS server of Peplink Balance.

The zone transfer server of Peplink Balance listens on TCP Port 53.

Zone Transfer	<input checked="" type="checkbox"/> Enable			
Allowed Client(s)	<table border="1"><tr><td>11.12.13.121</td><td rowspan="2">Delete Selected</td></tr><tr><td>11.12.13.122</td></tr></table> <input type="text" value="11.12.13.122"/>	11.12.13.121	Delete Selected	11.12.13.122
11.12.13.121	Delete Selected			
11.12.13.122				

Peplink Balance serves both the clients that are accessing from the specified IP addresses, and the clients that are accessing from the LAN Interface (of the Peplink Balance unit).

Default Connection Priority

Default Connection Priority defines the default priority group of each WAN connection in resolving A records. It applies to A records which have the Connection Priority set to **Default**. Please refer to Section 13.5.5 for the details.

The WAN connection(s) with the highest priority (smallest number) will be chosen. Those with lower priorities will not be chosen in resolving A records unless the higher priority ones become unavailable.



To specify the Primary and Backup connections, click the **Edit** button that corresponds to **Default Connection Priority**. The screen should assemble the one below.

Default Connection Priority	
1. WAN1	Default Priority: 1 (Highest) ▾
2. WAN2	Default Priority: 1 (Highest) ▾
3. WAN3	Default Priority: 3 ▾
4. Mobile Internet	Default Priority: 3 ▾

Each WAN connection is associated with a priority number. Click **Save** to save the settings when configuration is complete.

Domain name

This section shows a list of domain names to be hosted by the Peplink Balance. Each domain can have its "NS", "MX" and "TXT" records, and its or its sub-domains' "A" and "CNAME" records.

Input the domain name into the blank text field and press  to add as a new record. Click on a domain name to edit. Press  to remove a domain name.

13.5.1 Creating DNS Records

To create new DNS records for a domain, perform the following steps:

From **Network > Inbound Access > DNS Settings**, enter a domain name in the **Domain Name** field, press  to add record. Then click on the newly created domain name and the following screen will be displayed:

NS / SOA Records <i>(NS Record cannot be empty!)</i>				
TTL(sec)	Refresh(sec)	Retry(sec)	Expire(sec)	Min time(sec)
E-mail:				
Name Server		IP Address		

MX Records <i>(Empty)</i>	
TTL(sec):	
Mail Server	Priority

CNAME Records <i>(Empty)</i>			
Host	Reference	TTL(sec)	
New CNAME Record			

A Records <i>(Empty)</i>			
Host	Included IP Address(es)	TTL(sec)	
New A Record			

TXT Record <i>(Empty)</i>	
TTL(sec)	
Value	

This page is for defining the domain's NS, MX, CNAME, A and TXT records. Five tables are presented in this page for defining the five types of records.

13.5.2 NS / SOA Record

The NS / SOA Record table shows the NS servers, A records, TTL, Refresh Time, Retry Time, Expire Time, Minimum Time, and E-mail contact address that correspond to the domain.

To add or edit an NS record, click the upper **Edit** button in the **NS Record** box. Then the table will expand to look like the following:

NS / SOA Records <i>(NS Record cannot be empty!)</i>				
TTL(sec)	Refresh(sec)	Retry(sec)	Expire(sec)	Min time(sec)
<input type="text" value="3600"/>	<input type="text" value="16384"/>	<input type="text" value="2048"/>	<input type="text" value="1048576"/>	<input type="text" value="2560"/>
E-mail: <input type="text" value="hostmaster@mydomain.com"/>				
Name Server		IP Address		
NS1		55.66.77.88		
<input type="text"/>		<input type="text"/>		
		Delete		
		Add		

The first two rows are the settings of TTL, Refresh Time, Retry Time, Expiry Time, Minimum Time and E-mail:

- **TTL (Time-to-Live):** Defines the duration in seconds that the record may be cached
- **Refresh:** Indicates the time when the slave will try to refresh the zone from the master.
- **Retry:** Defines the time between retries if the slave (secondary) fails to contact the master when *refresh* (above) has expired.
- **Expire:** Indicates when the zone data is no longer authoritative.
- **Min Time:** Negative caching time – the time an error record is cached
- **E-mail:** Defines the E-mail address of the person responsible for this zone. Note: the “@” sign in the E-mail address field will be converted into a dot (“.”) in returning the SOA record.

You can enter a name server host name and its IP address into the two newly created text boxes. The host name can be a non-FQDN (fully qualified domain name). Click the **Add** button on the right to finish and to add the other one. After finishing adding NS records, click the **Save** button. (Before clicking the **Save** button, all NS record changes are not yet saved to the Peplink Balance.)

13.5.3 MX Record

The MX Record table shows the domain's MX records. Each MX record contains the priority and mail exchange server host name.

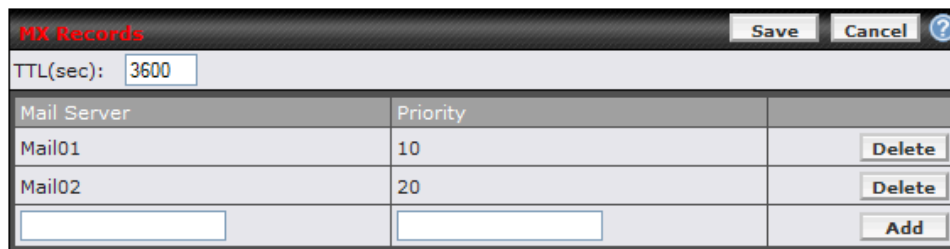

Mail Server	Priority	
Mail01	10	Delete
Mail02	20	Delete
<input type="text"/>	<input type="text"/>	Add

For each record, **Priority and Mail Server** name must be entered. **Priority** typically ranges from 10 to 100. Smaller numbers have a higher a priority. After finishing adding MX records, click the **Save** button.

13.5.4 CNAME Record

The CNAME Record table shows the domain's CNAME records. Here is how you use CNAME Records: If you want a sub-domain “secure” to have the same **A record** value(s) as “www”, then you can create a CNAME record for “secure” and reference it to “www”.

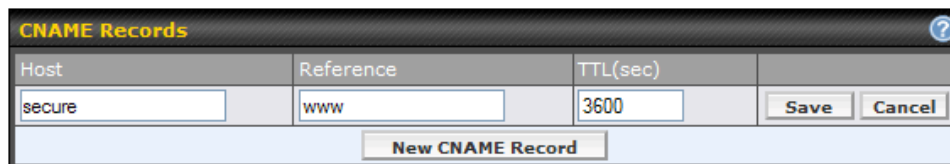

Host	Reference	TTL(sec)	
secure	www	3600	Save Cancel

New CNAME Record

The wildcard character “*” is supported in the **Host** field. The Reference of “*.domain.name” will be returned for every name ending with “.domain.name” except names that have their own records.

The **TTL** field tells the time to live of the record in external DNS caches.

13.5.5 A Record

This table shows the A records of the domain name.

A Records			
Host	Included IP Address(es)	TTL(sec)	
www	Custom:222.123.22.11 WAN1:12.12.13.22 WAN2:30.31.32.33	5	<input type="button" value="Edit"/> <input type="button" value="Delete"/>
<input type="button" value="New A Record"/>			

To add an A record, click the **New A Record** button. The screen resembles the one below:

A Record

Host Name

TTL second(s)

IP Mapping

Connection Priority

Default Custom

Connection / IP Address(es)

WAN1 Priority: 1 (Highest)

WAN2 Priority: 10 (Lowest)

WAN3

Mobile Internet

Custom IP

A Record Editing	
Host Name	This field specifies the A record of this sub-domain to be served by the Peplink Balance. The wildcard character "*" is supported. The IP addresses of "*.domain.name" will be returned for every name ending with ".domain.name" except names that have their own records.
TTL	This setting specifies the time to live of this record in external DNS caches. In order to reflect any dynamic changes on the IP addresses in case of link failure and recovery, this value should be set to a smaller value. E.g. 5 secs, 60 secs, etc.
IP Mapping	This setting specifies lists of WAN-specific Internet IP addresses that are candidates to be returned when Peplink Balance responds to DNS queries for the domain name specified by Host Name. The IP addresses listed in each box as default are the Internet IP addresses associated with each of the WAN connections. Static IP addresses that are not associated with any WAN can be entered into the Custom IP list. A PTR record is also created for each Custom IP's.

For WAN connections that operate under Drop-in mode, there may be other routable IP addresses in addition to the **default** IP address. Therefore, Peplink Balance allows custom Internet IP addresses to be added manually via filling the text box on the right-hand side and clicking the **Left Arrow** button.

Only the highlighted IP addresses in the lists are candidates to be returned when responding to a DNS query. (Multiple items in a list can be selected by holding CTRL and clicking on the items.)

In case of a WAN connection is down, the corresponding set of IP addresses will not be returned. However, the IP addresses in the Custom IP field will always be returned.

If the Connection Priority field is set to **Custom**, you can also specify the priority of the use of each WAN connection. Only selected IP address(es) of available connection(s) with the highest priority, and also Custom IP addresses will be returned. By default, the Connection Priority is set to **Default**.

13.5.6 PTR Record

PTR records are created along with A records pointing to Custom IPs. Please refer to **Section 13.5.5** for details. For example, if you created an A record *www.mydomain.com* pointing to *11.22.33.44*, then a PTR record *44.33.22.11.in-addr.arpa* pointing to *www.mydomain.com* will also be created.

When there are multiple host names pointing to the same IP address, only one PTR record for the IP address will be created.

In order to have the PTR records working, you will also have to create NS records for the PTR records. For example, if the IP address range *11.22.33.0* to *11.22.33.255* is delegated to the DNS server on the Peplink Balance, you will also have to create a domain *33.22.11.in-addr.arpa* and have its NS records pointing to your DNS server's (the Peplink Balance) public IP addresses.

NS / SOA Records				
TTL(sec)	Refresh(sec)	Retry(sec)	Expire(sec)	Min time(sec)
3600	16384	2048	1048576	2560
E-mail:	hostmaster			
Name Server	IP Address			
ns1	11.22.33.11			
ns2	11.22.33.22			

With the above records created, the PTR record creation is complete.

13.5.7 TXT Record

This table shows the TXT record of the domain name.

TXT Record	
TTL(sec)	3600
Value	This is a testing TXT record

Click the **Edit** button to edit the record. The time-to-live value and the TXT record's value can be entered. Click the **Save** button to finish.

After completed editing the five types of record, you can simply leave the page by going to another section of the Web Admin Interface.

Domain Delegation

These are the steps to be used when you host your domain at your ISP or a domain registrar and want to delegate a sub-domain to be resolved and managed at Peplink Balance.

1. Click  to add a domain name. e.g. *www.mycompany.com*. Click the corresponding domain name to view and edit record details.

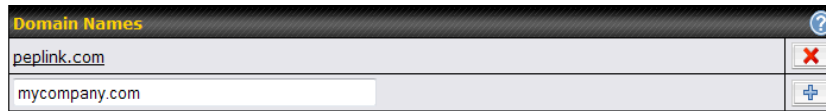

The screenshot shows a 'Domain Names' window with a table containing two entries: 'peplink.com' and 'mycompany.com'. The 'mycompany.com' entry has a plus icon to its right, indicating it can be selected for editing.

2. Create NS records named *ns1*, *ns2*, etc. The IP addresses are the Balance's DNS server addresses.

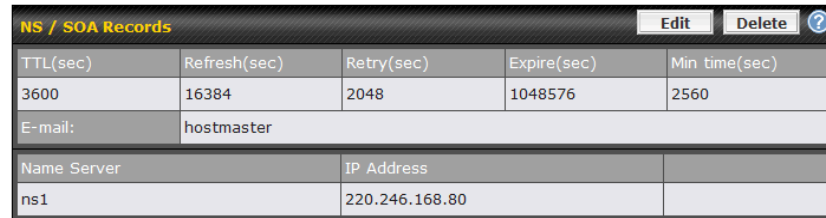

The screenshot shows the 'NS / SOA Records' configuration window. It includes fields for TTL(sec), Refresh(sec), Retry(sec), Expire(sec), and Min time(sec). Below these is an 'E-mail' field set to 'hostmaster'. A table lists Name Servers with their corresponding IP addresses:

Name Server	IP Address
ns1	220.246.168.80

3. Then create an A record with an empty host name:

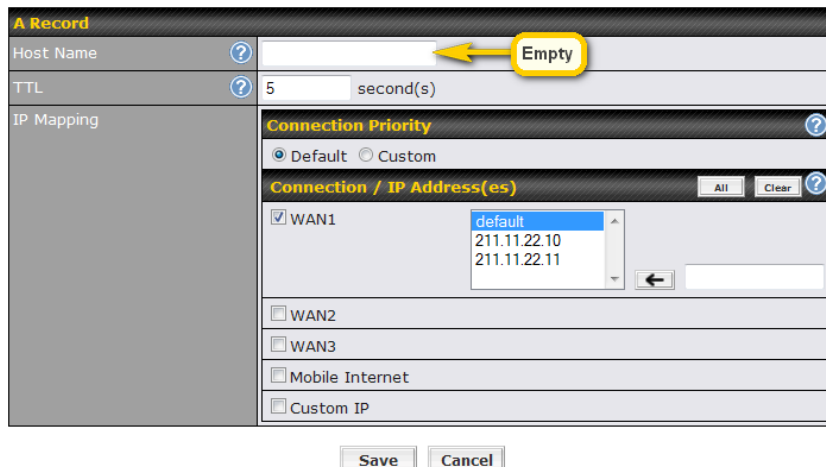

The screenshot shows the 'A Record' configuration window. The 'Host Name' field is empty, with a yellow callout bubble labeled 'Empty' pointing to it. The 'TTL' is set to 5 seconds. Under 'IP Mapping', 'WAN1' is selected, and a dropdown menu shows 'default', '211.11.22.10', and '211.11.22.11'. Below the window are 'Save' and 'Cancel' buttons.

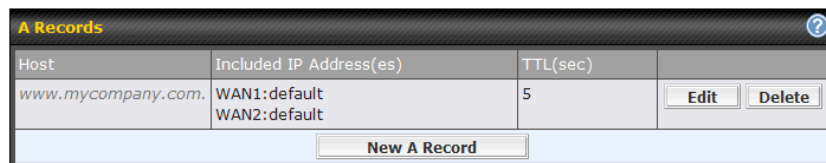

The screenshot shows the 'A Records' list window. It contains a table with the following data:

Host	Included IP Address(es)	TTL(sec)
www.mycompany.com.	WAN1:default WAN2:default	5

Buttons for 'Edit' and 'Delete' are visible next to the record, and a 'New A Record' button is at the bottom.

If ISC BIND 8 or 9 is being utilized in the zone file *mycompany.com*, then the addition of the following lines suffice:

```

www           IN      NS      balancewan1
www           IN      NS      balancewan2
balancewan1  IN      A       202.153.122.108
balancewan2  IN      A       67.38.212.18
    
```

202.153.122.108 and 67.38.212.18 represent the WAN1 and WAN2 Internet IP addresses of Peplink Balance, respectively. The values of the IP addresses are fictitious and for illustration only; the actual IP addresses in implementation will likely be different.

Hosting the complete domain at Peplink Balance

To host your own DNS server, contact the DNS registrar to have the NS records of the domain (e.g. mycompany.com) point to your Balance's WAN IP addresses. Then follow these instructions:

1. Under **Network > Inbound Access > DNS Settings**, create a new domain, for example mycompany.com.
2. Create NS records named ns1, ns2, etc. The IP addresses are the Balance's DNS server addresses (same as above).
3. Create the corresponding A, CNAME, MX and TXT records as you wish. The A record resembles the one below:

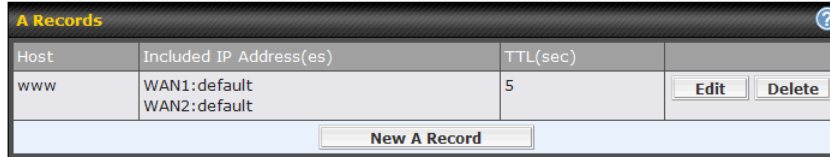

Host	Included IP Address(es)	TTL(sec)		
www	WAN1:default WAN2:default	5	Edit	Delete

New A Record

Testing the DNS Configuration

The following steps can be used to test the DNS configuration:

From a host on the Internet, use an IP address of Peplink Balance and nslookup to lookup the corresponding host name.

Check the information that is returned for the expected results.

An example with nslookup in Windows follows:

```
C:\Documents and Settings\User Name>nslookup
Default Server: ns1.myisp.com
Address: 147.22.11.2
> server 202.153.122.108 (This is Peplink Balance's WAN IP address.)
Default Server: balance.mycompany.com
Address: 202.153.122.108
> www.mycompany.com (This is the host name to be looked up.)
Default Server: balance.mycompany.com
Address: 202.153.122.108
Name: www.mycompany.com
Address: 202.153.122.109, 67.38.212.19
```

The values of the IP addresses are fictitious and for illustration only; the actual IP addresses in implementation will likely be different.

13.5.8 DNS Record Import Wizard

At the bottom of the page of DNS Settings, there is a link of *Import records via zone transfer...* which is used to import DNS record using Import Wizard.



- Select **Next>>** to continue.

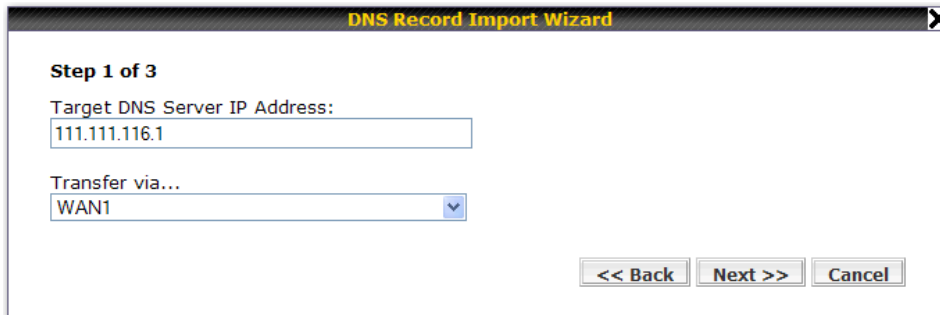

- In the **Target DNS Server IP Address** field, enter the IP address of the DNS server.
- In the **Transfer via...** field, choose which connection you would like to transfer through.
- Select **Next>>** to continue.

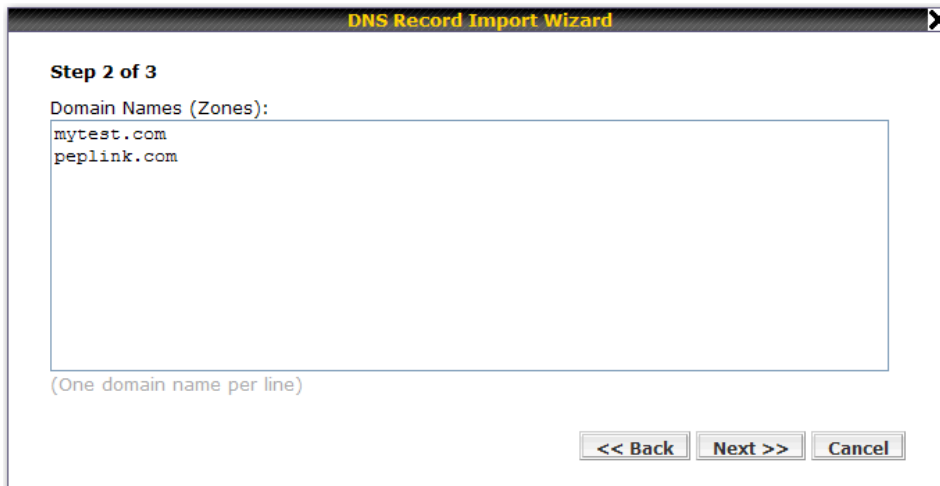

- In the blank space, enter the **Domain Names (Zones)** which you would like to assign with the IP address entered in the previous step. Enter one domain name per line.
- Select **Next>>** to continue.

Important Note

If you have entered domain(s) which already exist in your settings, a warning message like the following would be shown. Select **Next>>** to overwrite the existing record, or **<<Back** to go back to the previous step.

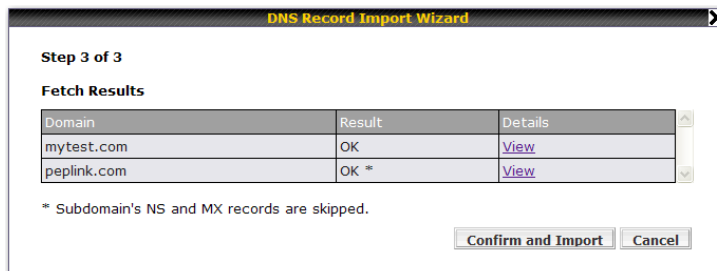
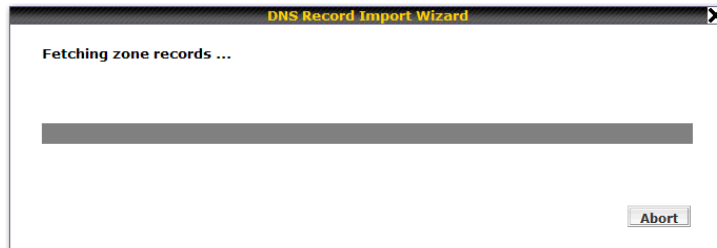

- After the Fetching zone records process has completed, the fetch results would be shown as above. You can view import details by clicking the corresponding hyperlink on the right hand side.

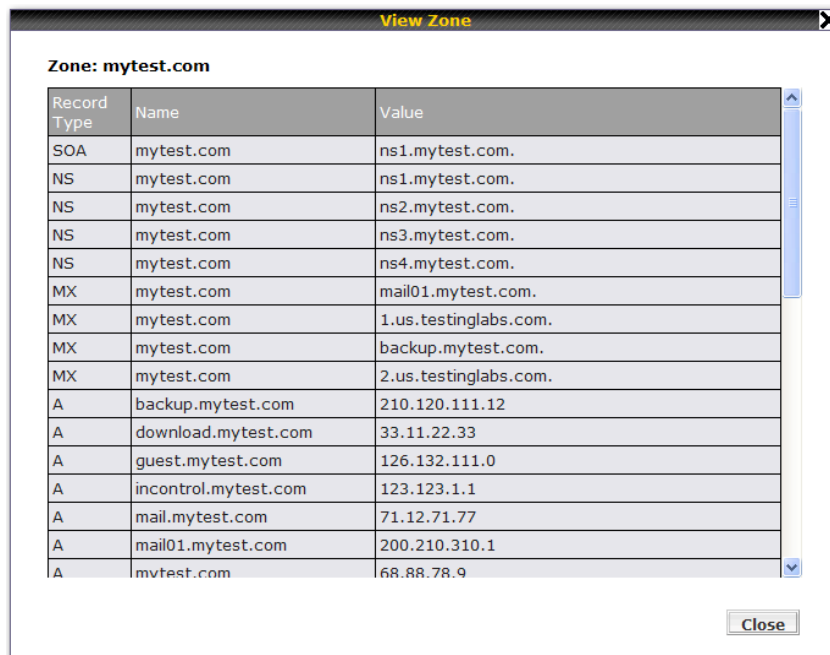

14 NAT Mappings

The configuration of NAT Mappings allows the IP address mapping of all inbound and outbound NAT'ed traffic to and from an internal client IP address.

The settings to configure NAT Mappings are located at: **Network > NAT Mappings**

LAN Host	Inbound Mappings	Outbound Mappings	Action
192.168.1.23	(WAN1):29.123.123.13	(WAN1):29.123.123.13	Delete
192.168.1.24	(WAN2):30.21.21.12	(WAN2):30.21.21.12	Delete

To add a rule for NAT Mappings, click **Add NAT Rule**, upon which the following screen will be displayed:

LAN Host	<input type="text" value="192.168.1.123"/>
Inbound Mappings	<p>Connection / Inbound IP Address(es)</p> <p><input checked="" type="checkbox"/> WAN1 <input type="checkbox"/> 123.123.123.1 (Interface IP)</p> <p><input type="checkbox"/> WAN2</p> <p><input type="checkbox"/> WAN3</p> <p><input type="checkbox"/> Mobile Internet</p>
Outbound Mappings	<p>Connection / Outbound IP Address</p> <p>WAN1 <input type="text" value="123.123.123.1 (Interface IP)"/></p> <p>WAN2 <input type="text" value="Interface IP"/></p> <p>WAN3 <input type="text" value="Interface IP"/></p> <p>Mobile Internet <input type="text" value="Interface IP"/></p>

NAT Mapping Settings	
LAN Host	This is the IP address of the host on the LAN that the system should map the selected connection IP address correspondences.
Inbound Mappings	<p>This setting specifies the WAN connections and corresponding WAN-specific Internet IP addresses on which the system should bind on. Any access to the specified WAN connection(s) and IP address(es) will be forwarded to the LAN Host.</p> <p>Note 1: Inbound Mapping is not needed for WAN connections in drop-in or IP forwarding mode.</p> <p>Note 2: Each WAN IP address can be associated to one NAT Mapping only.</p>
Outbound Mappings	<p>This setting specifies the IP address of each WAN connection to be used for any outgoing traffic originating from the LAN Host.</p> <p>Note 1: If you do not want to use a specific WAN for outgoing accesses, you should still choose default here, then customize the outbound access rule in the Outbound Policy section.</p> <p>Note 2: WAN connections in drop-in or IP forwarding mode are not shown here.</p>

Click **Save** to save the settings when configuration has been completed.

Important Note

Inbound firewall rules override Inbound Mapping settings.

15 QoS

15.1 User Groups

(This section applies only to Peplink Balance 380, 390, 580, 710 and 1350.)

LAN and PPTP clients can be categorized into three user groups - **Manager, Staff, and Guest**. This table allows you to define rules and assign client IP addresses or subnets to a user group. You can apply different bandwidth and traffic prioritization policies on each user group in the Bandwidth Control and Application sections.

The table is automatically sorted, and the table order signifies the rules' precedence. The smaller and more specific subnets are put towards the top of the table and have higher precedence; larger and less specific subnets are placed towards the bottom.

Click the **Add** button to define clients and their user group. Click the  button to remove the defined rule.

Two default rules are pre-defined and put at the bottommost. They are **All DHCP reservation clients** and **Everyone**, and they cannot be removed. **All DHCP reservation clients** represents the LAN clients defined in the DHCP Reservation table in the LAN settings page. **Everyone** represents all clients that are not defined in any rule above. Click on a rule to change its group.

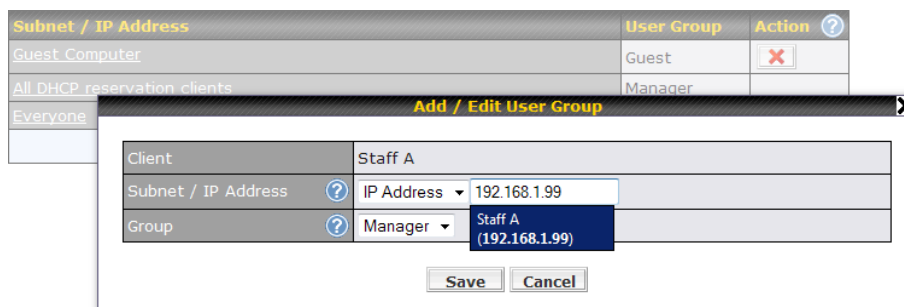

Add / Edit User Group	
Subnet / IP Address	From the drop-down menu, choose whether you are going to define the client(s) by an IP Address or a Subnet . If IP Address is selected, enter a name defined in DHCP Reservation table or a LAN client's IP address. If Subnet is selected, enter a subnet address and specify its subnet mask.
Group	This field is to define which User Group the specified Subnet / IP Address belongs to.

Once users have been assigned to a user group, their internet traffic will be restricted by rules defined for that particular group. Please refer to the following two sections for details.

15.2 Bandwidth Control

(This section applies only to Peplink Balance 380, 390, 580, 710 and 1350.)

This section is to define how much minimum bandwidth will be reserved to each user group when a WAN connection is **in full load**. When this feature is enabled, a slider with two indicators will be shown. You can move the indicators to adjust each group's weighting. The lower part of the table shows the corresponding reserved download and upload bandwidth value of each connection.

By default, **50%** of bandwidth has been reserved for Manager, **30%** for Staff, and **20%** for Guest.

Group Bandwidth Reservation				
Enable	<input checked="" type="checkbox"/>			
Group Reserved Bandwidth		↕	↕	
		Manager	Staff	Guest
	% BW	50%	30%	20%
	WAN1	50.0M/50.0M	30.0M/30.0M	20.0M/20.0M
	WAN2	3.9M/4.0M	2.3M/2.4M	1.6M/1.6M
WAN3	750k/1.0M	450k/614k	300k/410k	

You can define a maximum download speed (over all WAN connections) and upload speed (for each WAN connection) that each individual Staff and Guest member can consume. No limit can be imposed on individual Manager members.

By default, Download and Upload Bandwidth Limits are set to unlimited (set as **0**).

Individual Bandwidth Limit			
Enable	<input checked="" type="checkbox"/>		
User Bandwidth Limit	Download		Upload
	Manager: Unlimited		Unlimited
	Staff:	20 Mbps	10 Mbps (0: unlimited)
	Guest:	500 Kbps	100 Kbps (0: unlimited)

15.3 Application

(This section applies only to Peplink Balance 210, 310, 380, 390, 580, 710 and 1350.)

15.3.1 Application Prioritization

For Peplink Balance 210 and 310:

Three priority levels can be set for application prioritization: ↑ **High**, — **Normal**, and ↓ **Low**.

Four types of applications are predefined. Their priority can be selected from their corresponding drop down menu. Traffic types not defined in the table are assigned with normal priority.

Application	Priority	Action ?
PPTP and IPsec VPN	— Normal	
SIP/Vonage	— Normal	
Skype, Google Talk, RealVideo, and Windows Streaming Media	↑ High	
Secure Web (HTTPS)	↓ Low	
<input type="button" value="Add"/>		

Application Prioritization	
PPTP and IPsec VPN	When enabled, any PPTP and IPsec traffic will be prioritized.
SIP/Vonage	When enabled, any SIP and Vonage voice traffic will be prioritized.
Skype, Google Talk, RealVideo, and Windows Streaming Media	When enabled, voice and video traffic of Skype, Google Talk, RealVideo and Windows Streaming Media will be prioritized.
Secure Web (HTTPS)	When enabled, HTTPS (TCP port 443) traffic will be prioritized.

For Peplink Balance 380, 390, 580, 710 and 1350:

You can choose whether to apply the same Prioritization settings to all user groups or customize the settings for each group.

Application Prioritization
<input type="radio"/> Apply same settings to all users <input checked="" type="radio"/> Customize

Three priority levels can be set for application prioritization: ↑ **High**, — **Normal**, and ↓ **Low**.

Four types of applications are predefined. Their priority for each user group can be selected from their corresponding drop down menu. Traffic types not defined in the table are assigned with normal priority.

Application	Priority			Action
	Manager	Staff	Guest	
PPTP and IPsec VPN	— Normal	— Normal	— Normal	
SIP/Vonage	↑ High	↑ High	↑ High	
Skype, Google Talk, RealVideo, and Windows Streaming Media	— Normal	— Normal	— Normal	
Secure Web (HTTPS)	— Normal	— Normal	— Normal	
Custom Application				
Testing	↓ Low	↓ Low	↓ Low	
<input type="button" value="Add"/>				

15.3.2 Prioritization for Custom Application

Click the **Add** button to define a custom application. Click the button  in the **Action** column to delete the custom application in the corresponding row.

Add / Edit Custom Application ✕

Application Name	Testing
Scope / Protocol	TCP
Port	Single Port 12345

By default, this feature is enabled.

15.3.3 DSL/Cable Optimization

DSL/cable-based WAN connection has its upload bandwidth lower than the download bandwidth. When this option is enabled, the download bandwidth of the WAN can be fully utilized in any situation.

When a DSL/cable circuit's uplink is congested, the download bandwidth will be affected. Users will not be able to download data in full speed until the uplink becomes less congested. The DSL/Cable Optimization can relieve such issue. When it is enabled, the download speed will become less affected by the upload traffic.

By default, this feature is enabled.

DSL/Cable Optimization ?

Enable	<input checked="" type="checkbox"/>
--------	-------------------------------------

16 Firewall

A firewall is a mechanism that selectively filters data traffic between the WAN side (the Internet) and the LAN side of the network. It can protect the local network from potential hacker attacks, offensive Web sites, and/or other inappropriate uses.

The firewall functionality of Peplink Balance supports the selective filtering of data traffic in both directions:

- Outbound (LAN to WAN)
- Inbound (WAN to LAN)
- Intrusion Detection and DoS Prevention

With Site-to-Site VPN enabled (see **Section 11**), the firewall rules also apply to VPN tunneled traffic.

16.1 Outbound and Inbound Firewall

The outbound and inbound firewall settings are located at: **Network > Firewall**

Outbound Firewall Rules (Drag and drop rows to change rule order)					
Rule	Protocol	Source IP Port	Destination IP Port	Policy	
Default	Any	Any	Any	Allow	
Add Rule					

Inbound Firewall Rules (Drag and drop rows to change rule order)					
Rule	Protocol	WAN	Source IP Port	Destination IP Port	Policy
Default	Any	Any	Any	Any	Allow
Add Rule					

Upon clicking **Add Rule**, the following screen appears:

Add a New Inbound Firewall Rule

New Firewall Rule	
Rule Name *	<input type="text"/>
Enable	<input checked="" type="radio"/> Yes <input type="radio"/> No
WAN Connection	Any
Protocol	Any ← :: Protocol Selection Tool ::
Source IP & Port	Any Address
Destination IP & Port	Any Address
Action	<input checked="" type="radio"/> Allow <input type="radio"/> Deny
Event Logging	<input type="checkbox"/> Enable

Inbound / Outbound Firewall Settings									
Rule Name	This setting specifies a name for the firewall rule.								
Enable	<p>This setting specifies whether the firewall rule should take effect.</p> <p>When Yes is selected, the firewall rule takes effect. If the traffic matches the specified Protocol/IP/Port, actions will be taken by Peplink Balance based on the other parameters of the rule.</p> <p>When No is selected, the firewall rule does not take effect. Peplink Balance will disregard the other parameters of the rule.</p>								
WAN Connection	<p>This setting is applicable to Inbound Firewall Rules only.</p> <p>This setting specifies the WAN connection(s) on which the rule applies:</p> <ul style="list-style-type: none"> • Any • WAN1 • WAN2 • WAN3 (applicable only to Peplink Balance 30, 310, 380, 390, 580, 710 and 1350) • WAN4 to WAN5 (applicable only to Peplink Balance 580, 710 and 1350) • WAN6 to WAN7 (applicable only to Peplink Balance 710 and 1350) • WAN8 to WAN13 (applicable only to Peplink Balance 1350) • Mobile Internet (applicable only to Peplink Balance 20, 30, 380, 390, 580, 710 and 1350) <p>A value of Any, WAN1, WAN2, ... and Mobile Internet specifies that the rule applies to all WAN connections, WAN1, WAN2, ... and Mobile Internet, respectively.</p>								
Protocol	<p>This setting specifies the protocol to be matched.</p> <p>Via a drop-down menu, the following protocols can be specified:</p> <ul style="list-style-type: none"> • TCP • UDP • ICMP • IP <p>Alternatively, the Protocol Selection Tool drop-down menu can be used to automatically fill in the Protocol and Port number of common Internet services (e.g. HTTP, HTTPS, etc.) After selecting an item from the Protocol Selection Tool drop-down menu, the Protocol and Port number remains manually modifiable.</p>								
Source IP & Port	<p>This specifies the source IP address(es) and port number(s) to be matched for a firewall rule.</p> <p>A single address, or a network, can be specified as the Source IP & Port setting, as indicated with the following screenshots:</p> <div style="border: 1px solid #ccc; padding: 5px; margin: 10px 0;"> <table style="width: 100%; border-collapse: collapse;"> <tr> <td style="padding: 2px;">Single Address</td> <td style="padding: 2px;">IP: <input style="width: 150px;" type="text"/></td> </tr> <tr> <td style="padding: 2px;">Single Port</td> <td style="padding: 2px;">Port: <input style="width: 50px;" type="text"/></td> </tr> <tr> <td style="padding: 2px;">Network</td> <td style="padding: 2px;">IP: <input style="width: 150px;" type="text"/> Mask: <input style="width: 100px;" type="text" value="255.255.255.0"/></td> </tr> <tr> <td style="padding: 2px;">Port Range</td> <td style="padding: 2px;">Port: <input style="width: 50px;" type="text"/> - <input style="width: 50px;" type="text"/></td> </tr> </table> </div> <p>In addition, a single port, or a range of ports, can be specified for the Source IP & Port setting.</p>	Single Address	IP: <input style="width: 150px;" type="text"/>	Single Port	Port: <input style="width: 50px;" type="text"/>	Network	IP: <input style="width: 150px;" type="text"/> Mask: <input style="width: 100px;" type="text" value="255.255.255.0"/>	Port Range	Port: <input style="width: 50px;" type="text"/> - <input style="width: 50px;" type="text"/>
Single Address	IP: <input style="width: 150px;" type="text"/>								
Single Port	Port: <input style="width: 50px;" type="text"/>								
Network	IP: <input style="width: 150px;" type="text"/> Mask: <input style="width: 100px;" type="text" value="255.255.255.0"/>								
Port Range	Port: <input style="width: 50px;" type="text"/> - <input style="width: 50px;" type="text"/>								

Destination IP & Port

This specifies the destination IP address(es) and port number(s) to be matched for a firewall rule.

A single address, or a network, can be specified as the Source IP & Port setting, as indicated with the following screenshots:

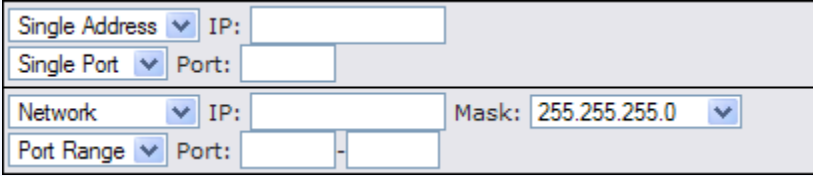

In addition, a single port, or a range of ports, can be specified for the Source IP & Port setting.

Action

This setting specifies the action to be taken by Peplink Balance upon encountering traffic that matches the both of the following:

- Source IP & Port
- Destination IP & Port

With the value of **Allow** for the Action setting, the matching traffic passes through Peplink Balance (to be routed to the destination).

If the value of the Action setting is set to **Deny**, the matching traffic does not pass through Peplink Balance (and is discarded).

Event Logging

This setting specifies whether or not to log matched firewall events.

The logged messages are shown on the page Status > Event Log.

A sample message is as follows:

```
Aug 13 23:47:44 Denied CONN=Ethernet WAN SRC=20.3.2.1
DST=192.168.1.20 LEN=48 PROTO=TCP SPT=2260 DPT=80
```

- **CONN:** The connection where the log entry refers to
- **SRC:** Source IP address
- **DST:** Destination IP address
- **LEN:** Packet length
- **PROTO:** Protocol
- **SPT:** Source port
- **DPT:** Destination port

Upon clicking **Save** after entering required information, the following screen appears.

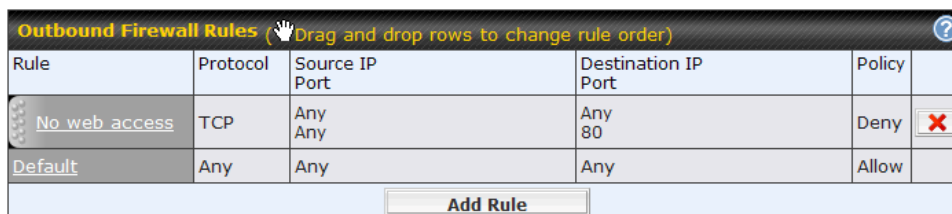



Rule	Protocol	Source IP Port	Destination IP Port	Policy	
No web access	TCP	Any Any	Any 80	Deny	
Default	Any	Any	Any	Allow	

Add Rule

To create an additional firewall rule, click **Add Rule** and repeat the above steps.

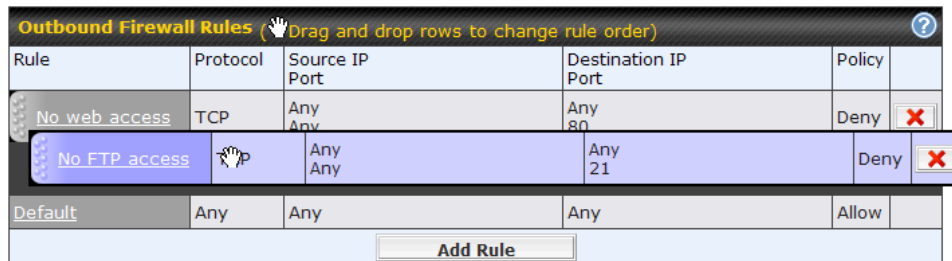
To reorder a rule's position, just drag on the rule by holding the left mouse button, move it to the desired position and drop it by releasing the mouse button.



Rule	Protocol	Source IP Port	Destination IP Port	Policy	
No_web_access	TCP	Any Any	Any 80	Deny	
No FTP access		Any Any	Any 21	Deny	
Default	Any	Any	Any	Allow	

To remove a rule, click .

Rules are matched from top to the bottom. If a connection matches any one of the upper rules, the matching process will stop. If none of the rules is matching, the **Default** rule will be applied.

By default, the **Default** rule is **Allow** for both outbound and inbound accesses.

Tip

If the default inbound rule is set as **Allow** for NAT enabled WANs, no inbound Allow firewall rules will be required for inbound Port Forwarding and inbound NAT Mapping rules. However, if the default inbound rule is set as **Deny**, a corresponding Allow firewall rules will be required.

16.2 Intrusion Detection and DoS Prevention

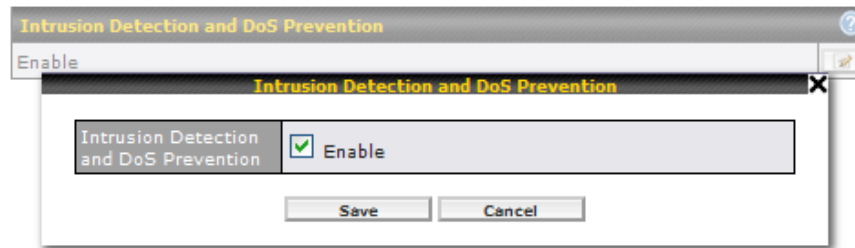

The Balance supports detecting and preventing intrusions and Denial-of-Service (DoS) attacks from the Internet. To turn on this feature, click , check the **Enable** check box for the **Intrusion Detection and DoS Prevention** and press the **Save** button.

When this feature is enabled, the Balance will detect and protect from the following kinds of intrusions and denial-of-service attacks.

- Port Scan:
 - NMAP FIN/URG/PSH
 - Xmas Tree
 - Another Xmas Tree
 - Null Scan
 - SYN/RST
 - SYN/FIN
- SYN Flood Prevention
- Ping Flood Attack Prevention

17 Miscellaneous Settings

The miscellaneous settings include configuration for High Availability, PPTP Server, Service Forwarding, and Service Passthrough.

17.1 High Availability

(This section applies only to Peplink Balance 210, 310, 380, 390, 580, 710 and 1350.)

Peplink Balance supports High Availability (HA) configurations via an open standard Virtual Router Redundancy Protocol (VRRP, RFC 3768).

In an HA configuration, two same-model Peplink Balance units (e.g. a pair of Peplink Balance 210 units, or a pair of Peplink Balance 710 units) provide redundancy and failover in a master-slave arrangement. From a high level, in the event that the Master Unit is down, the Slave Unit becomes active.

High Availability will be disabled automatically where there is a Drop-in connection configured on a LAN Bypass port.

The following diagram illustrates an HA configuration with two Peplink Balance 210 units, and two Internet connections:

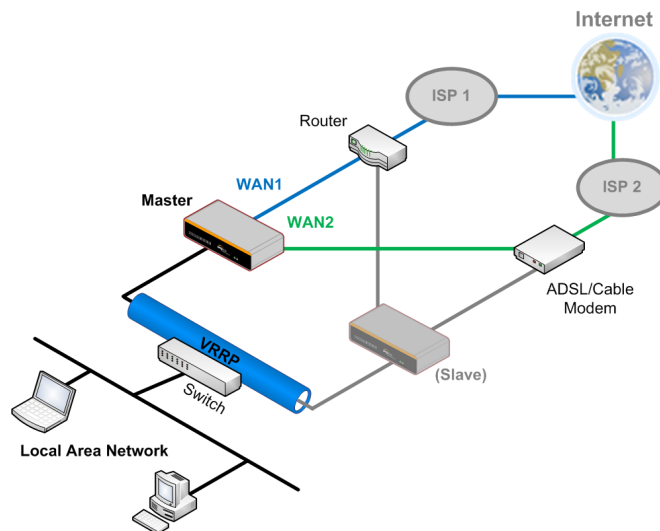









In the diagram, the WAN ports on each Peplink Balance unit connect to the router and modem; and Peplink Balance unit connects to the same LAN switch via a LAN port.

An elaboration on the technical details of the implementation, by Peplink Balance, of Virtual Router Redundancy Protocol (VRRP, RFC 3768) follows:

- In an HA configuration, the two Peplink Balance units communicate with each other using VRRP over the LAN.
- The two Peplink Balance units broadcast heartbeat signals to the LAN at a frequency of one heartbeat signal per second.
- In the event that no heartbeat signal from the Master Peplink Balance unit is received in 3 seconds (or longer) since the last heartbeat signal, the Slave Peplink Balance unit becomes active.
- The Slave Peplink Balance unit initiates the WAN connections, and binds to a previously configured LAN IP address.
- At a subsequent point when the Master Peplink Balance unit recovers, it will once again become active.

The settings to configure High Availability are located at the following location: **Network > Misc. Settings > High Availability**:

High Availability Setup		
High Availability		<input checked="" type="checkbox"/> Enable
Group Number (1-255)		<input type="text" value="20"/>
Preferred Role		<input type="radio"/> Master <input checked="" type="radio"/> Slave
Configuration Sync.		<input checked="" type="checkbox"/>
Master Serial Number		<input type="text" value="1824-1234-1234"/>
Virtual IP		<input type="text" value="192.168.1.1"/>
LAN Administration IP		<input type="text" value="192.168.1.3"/>
Subnet Mask		<input type="text" value="255.255.255.0"/>

High Availability Settings	
High Availability	Checking this box specifies that the Peplink Balance unit is part of a High Availability configuration.
Group Number	This setting specifies a number that identifies a pair of Peplink Balance units that operate in a High Availability configuration. The two Peplink Balance units in the pair must have the same Group Number value.
Preferred Role	This setting specifies whether the Peplink Balance unit operates in Master or Slave mode. Click the corresponding radio button to set the role of the unit. One of the units in the pair must be configured as the Master and the other unit must be configured as the Slave
Configuration Sync.	This option is displayed when Slave mode is selected in Preferred Role. If this option is enabled and the Master Serial Number entered matches with the actual master unit's, the master unit will automatically transfer the configuration to this unit. Please make sure the LAN IP Address and Subnet Mask fields are set correctly in the LAN Settings page. You can refer to the Event Log for the configuration synchronization status.
Master Serial Number	If the box Configuration Sync. is checked, serial number of the Master unit is required to be entered here.
Virtual IP	The setting specifies the LAN IP address on which the active Peplink Balance listens. The value of Virtual IP represents a LAN IP address that is shared among the Master and Slave units; however, at any time, only one of the two units will listen on the IP address. If the WAN is configured in NAT mode, Default Gateway of the clients on the LAN should be set to the virtual IP. These configurations are not required when the WAN is configured in Drop-in mode.
LAN Administration IP	This setting specifies a LAN IP address to be used for accessing administration functionality. This address should be unique within the LAN.
Subnet Mask	This setting specifies the subnet mask of the LAN.

Important Note

For Balance in NAT mode, the VIP should be set as the default gateway for all hosts sitting on the LAN segment. For example, a firewall sitting behind the Balance should set its default gateway as the VIP instead of the IP of Master Balance.

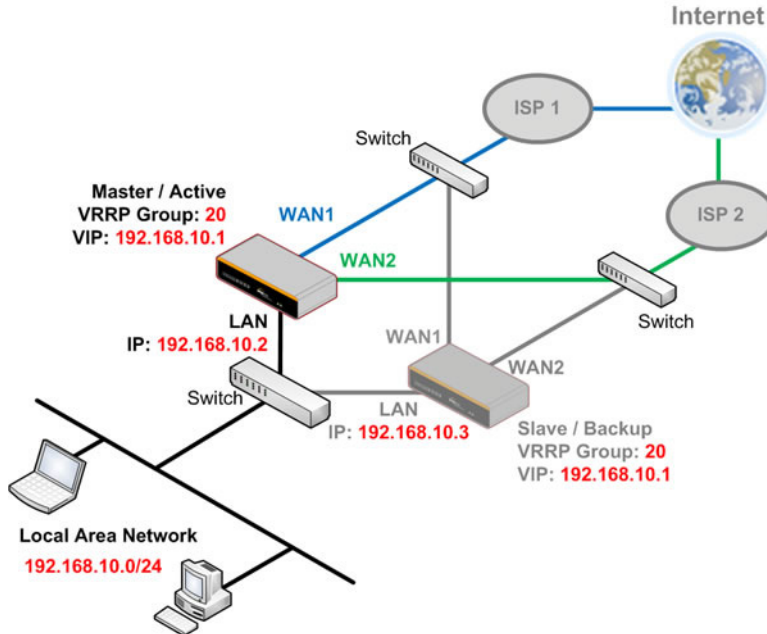

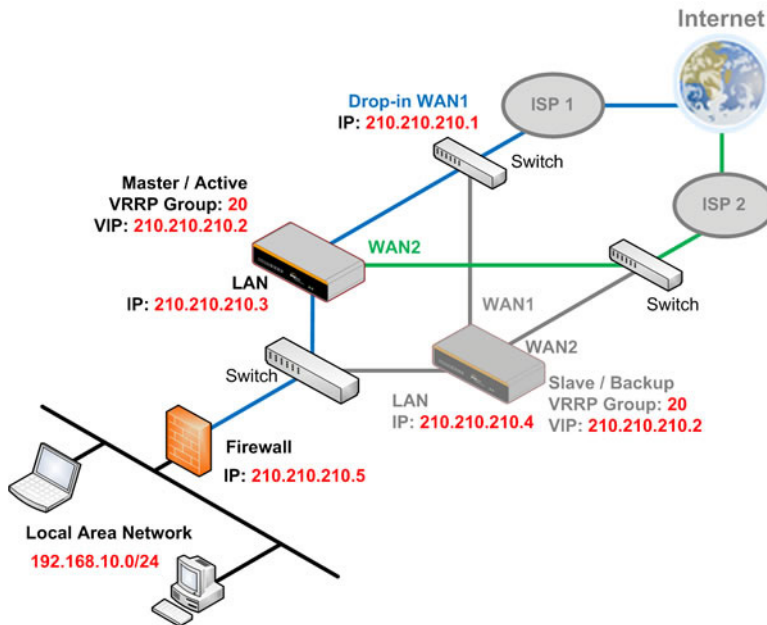

In Drop-in mode, no other configuration needs to be set.



Please be noted that Drop-in WAN cannot be configured in LAN Bypass port when it is configuring High Availability.

17.3 Service Forwarding

Service Forwarding settings are located at: **Network > Service Forwarding**

SMTP Forwarding Setup 	
SMTP Forwarding	<input type="checkbox"/> Enable
Web Proxy Forwarding Setup 	
Web Proxy Forwarding	<input type="checkbox"/> Enable
DNS Forwarding Setup 	
Forward Outgoing DNS Requests to Local DNS Proxy	<input type="checkbox"/> Enable

Service Forwarding	
SMTP Forwarding	When this option is enabled, all outgoing SMTP connections destined for any host at TCP port 25 will be intercepted. These connections will be redirected to a specified SMTP server and port number. SMTP server settings for each WAN can be specified after selecting Enable .
Web Proxy Forwarding	When this option is enabled, all outgoing connections destined for the proxy server specified in Web Proxy Interception Settings will be intercepted. These connections will be redirected to a specified web proxy server and port number. Web Proxy Interception Settings and proxy server settings for each WAN can be specified after selecting Enable .
DNS Forwarding	When this option is enabled, all outgoing DNS lookups will be intercepted and redirected to the built-in DNS name server. If any LAN device is using DNS name servers of a WAN connection, you may want to enable this option to enhance the DNS availability without modifying the DNS server setting of the clients. The built-in DNS name server will distribute DNS lookups to corresponding DNS servers of all available WAN connections. In this case, DNS service will not be interrupted even if any WAN connection is down.

17.3.1 SMTP Forwarding

Some ISPs require their users to send e-mails via the ISP's SMTP server. All outgoing SMTP connections are blocked except those connecting to the ISP's. The Peplink Balance supports to intercept and redirect all outgoing SMTP connections (destined for TCP port 25) via a WAN connection to the WAN's corresponding SMTP server.

SMTP Forwarding Setup 			
SMTP Forwarding		<input checked="" type="checkbox"/> Enable	
Connection	Enable Forwarding?	SMTP Server	SMTP Port
WAN1	<input type="checkbox"/>	<input type="text"/>	<input type="text"/>
WAN2	<input checked="" type="checkbox"/>	22.2.2.2	25
WAN3	<input checked="" type="checkbox"/>	33.3.3.2	25
Mobile Internet	<input type="checkbox"/>	<input type="text"/>	<input type="text"/>

To enable the feature, select the **Enable** check box under *SMTP Forwarding Setup*. Check the box **Enable Forwarding?** for the WAN connection(s) that needs such forwarding. Enter the ISP's e-mail server host name or IP address and TCP port number for each WAN.

The Peplink Balance will intercept SMTP connections, choose a WAN with reference to the Outbound Policy, and then forward the connection to the forwarded SMTP server if the chosen WAN has enabled forwarding. If the forwarding is disabled for a WAN connection, SMTP connections for the WAN will be simply forwarded to the connection's original destination.

Note

If you want to route all SMTP connections only to particular WAN connection(s), you should create a custom rule in Outbound Policy (see Section 12.1).

17.3.2 Web Proxy Forwarding

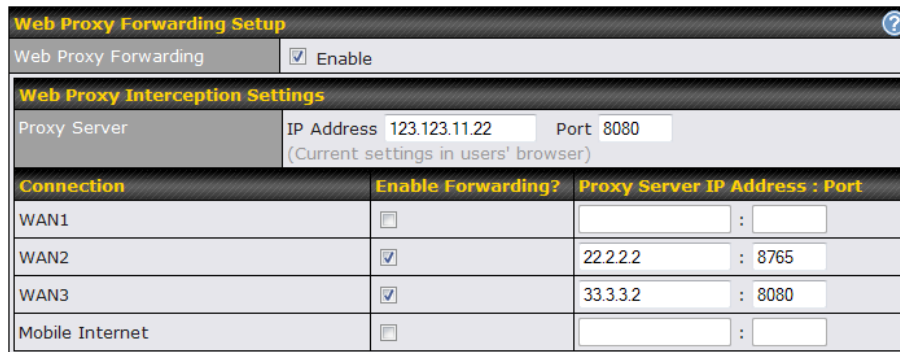

Web Proxy Forwarding Setup ?

Web Proxy Forwarding Enable

Web Proxy Interception Settings

Proxy Server IP Address 123.123.11.22 Port 8080
(Current settings in users' browser)

Connection	Enable Forwarding?	Proxy Server IP Address : Port
WAN1	<input type="checkbox"/>	:
WAN2	<input checked="" type="checkbox"/>	22.2.2.2 : 8765
WAN3	<input checked="" type="checkbox"/>	33.3.3.2 : 8080
Mobile Internet	<input type="checkbox"/>	:

When this feature is enabled, the Peplink Balance will intercept all outgoing connections destined for the proxy server specified in "Web Proxy Server Interception Settings", choose a WAN connection with reference of Outbound Policy, and then forward them to the specified web proxy server and port number. Redirected server settings for each WAN can be set here. If Forwarding is disabled for a WAN, web proxy connections for the WAN will be simply forwarded to the connection's original destination.

17.3.3 DNS Forwarding

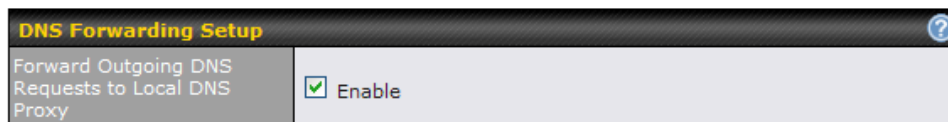

DNS Forwarding Setup ?

Forward Outgoing DNS Requests to Local DNS Proxy Enable

When DNS Forwarding is enabled, all clients' outgoing DNS requests will also be intercepted and forwarded to the built-in DNS proxy server.

17.4 Service Passthrough

Service Passthrough settings can be found at: **Network > Misc. Settings > Service Passthrough**

Service Passthrough Support	
SIP (Standard SIP, Vonage)	<input checked="" type="radio"/> Standard Mode <input type="radio"/> Compatibility Mode <input checked="" type="checkbox"/> Define custom signal ports 1. <input type="text"/> 2. <input type="text"/> 3. <input type="text"/>
H.323	<input checked="" type="checkbox"/> Enable
FTP	<input checked="" type="checkbox"/> Enable <input type="checkbox"/> Define custom control ports
TFTP	<input checked="" type="checkbox"/> Enable
IPsec NAT-T	<input checked="" type="checkbox"/> Enable <input type="checkbox"/> Define custom ports <input checked="" type="checkbox"/> Route IPsec Site-to-Site VPN via WAN1 ▼

(Registered trademarks are copyrighted by their respective owner)

Some Internet services required to be specially handled in a multi-WAN environment. The Peplink Balance supports handling such services correctly such that Internet applications do not notice it is behind a multi-WAN router. Settings for Service Passthrough Support are available here.

Service Passthrough Support	
SIP	<p>Session Initiation Protocol, aka SIP, is a voice-over-IP protocol. Peplink Balance can act as a SIP Application Layer Gateway (ALG) which binds connections for the same SIP session to the same WAN connection and translate IP address in the SIP packets correctly in NAT mode. Such passthrough support is always enabled and there are two modes for selection: Standard Mode and Compatibility Mode</p> <p>If your SIP server's signal port number is non-standard, you can check the box Define custom signal ports and input the port numbers to the text boxes.</p>
H.323	<p>With this option enabled, protocols that provide audio-visual communication sessions will be defined on any packet network and passthrough the Balance.</p>
FTP	<p>FTP sessions consist of two TCP connections; one for control and one for data. In multi-WAN situation, they have to be binded to the same WAN connection. Otherwise, problems will arise in transferring files. By default, the Peplink Balance monitors TCP control connections on port 21 for any FTP connections and binds TCP connections of the same FTP session to the same WAN.</p> <p>If you have an FTP server listening on a port number other than 21, you can check the box Define custom control ports and enter the port numbers to the text boxes.</p>
TFTP	<p>The Peplink Balance monitors outgoing TFTP connections and routes any incoming TFTP data packets back to the client. Select Enable if you want to enable the TFTP Passthrough support.</p>
IPsec NAT-T	<p>This field is for enabling the support of IPsec NAT-T Passthrough. UDP ports 500, 4500 and 10000 are monitored by default.</p> <p>You may add more custom data ports that your IPsec system uses by checking the box Define custom ports. If the VPN contains IPsec Site-to-Site VPN traffic, you have to check the box Route IPsec Site-to-Site VPN and choose the WAN connection to route the traffic to.</p> <p>If you have IPsec Site-to-Site VPN traffic routed, check the Route IPsec Site-to-Site VPN option and select a WAN to force routing such traffic to the specified WAN.</p>

18 System Settings

18.1 Admin Security

There are two user accounts available for accessing the Web Admin. Usernames are **admin** and **user**. They represent two user levels - **admin** has full administration access, while **user** is a read-only account. The read-only account can only access the device's status information and cannot make any change on the device.

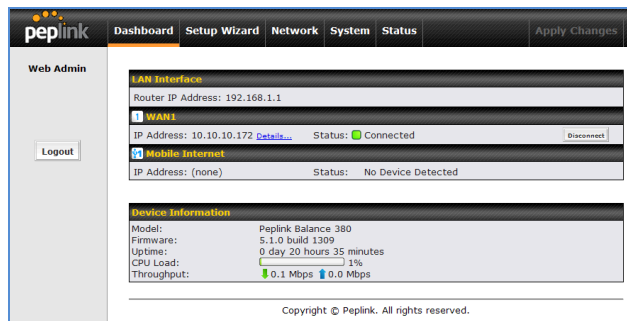

Admin Account UI

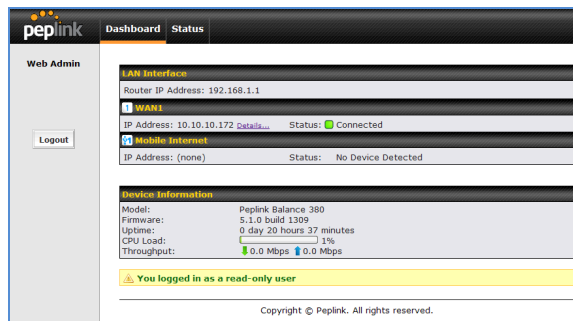

User Account UI

A web login session will be logged out automatically when it has been idled for a longer time than the **Web Session Timeout**. The default timeout is 4 hours 0 minute. Before the session expires, you may click the **Logout** button in the Web Admin to exit from the session.

For security reason, after logging in to the Web Admin Interface for the first time, it is recommended to change the administrator password.

Configuring the administration interface to be accessible only from the LAN can further improve system security.

Administrative Settings configuration is located at: **System > Admin Security**

Admin Settings	
Router Name	Balance_XXXX
Admin User Name	admin
Admin Password *	••••••••
Confirm Admin Password *	••••••••
Read-only User Name	user
User Password	••••••••
Confirm User Password	••••••••
Web Session Timeout	4 Hours 0 Minutes
Security	HTTP/HTTPS
Web Admin Port	HTTP: 80 HTTPS: 443 Default
Web Admin Access	HTTP: LAN/WAN HTTPS: LAN Only

WAN Connection Access Settings

Allowed Source IP Subnets ? Any Allow access from the following IP subnets only

12.34.45.0/24
11.22.33.0/24

Allowed WAN IP Address(es)

Connection / IP Address(es)	
<input checked="" type="checkbox"/> WAN1	<input checked="" type="checkbox"/> 123.123.123.1 (Interface IP) <input type="checkbox"/> 123.123.123.10 <input type="checkbox"/> 123.123.123.11
<input checked="" type="checkbox"/> WAN2	<input checked="" type="checkbox"/> Interface IP <input type="checkbox"/> 1.1.1.1
<input type="checkbox"/> WAN3	
<input type="checkbox"/> Mobile Internet	

Admin Settings	
Router Name	This field allows you to define a name for this Peplink Balance unit. By default, Router Name is set as Balance_XXXX , where XXXX refers to the last 4 digits of the serial number of that balance unit.
Admin User Name	It is set as admin by default and is not customizable.
Admin Password	This field allows you to specify a new administrator password.
Confirm Admin Password	This field allows you to verify and confirm the new administrator password.
Read-only User Name	It is set as user by default and is not customizable.
User Password	This field allows you to specify a new user password. Once the user password is set, the feature of read-only user will be enabled.
Confirm User Password	This field allows you to verify and confirm the new user password.
Web Session Timeout	This field specifies the number of hours and minutes that a web session can remain idle before the balance terminates its access to Web Admin Interface. By default, it is set as 4 hours .
Security	This option is for specifying the protocol(s) through which the Web Admin Interface can be accessible: <ul style="list-style-type: none"> • HTTP • HTTPS • HTTP/HTTPS

Web Admin Port These fields are for specifying the port number at which the Web Admin Interface can be accessible.

This option is for specifying the network interfaces through which the Web Admin Interface can be accessible:

Web Admin Access

- LAN only
- LAN/WAN

If LAN/WAN is chosen, a WAN Connection Access Settings form will be displayed.

WAN Connection Access Settings

This field allows you to restrict web admin access only from defined IP subnets.

- **Any** - Allow web admin accesses to be from anywhere, without IP address restriction.
- **Allow access from the following IP subnets only** - Restrict web admin access only from the defined IP subnets. When this is chosen, a text input area will be displayed beneath:

Allowed Source IP Subnets

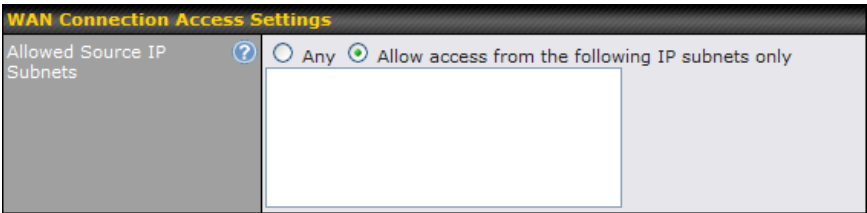

The allowed IP subnet addresses should be entered into this text area. Each IP subnet must be in form of *w.x.y.z/m* where *w.x.y.z* is an IP address (e.g. 192.168.0.0), and *m* is the subnet mask in CIDR format, which is between 0 and 32 inclusively. For example: *192.168.0.0/24*

To define multiple subnets, separate each IP subnet one in a line.
 For example:
192.168.0.0/24
10.8.0.0/16

This is to choose which WAN IP address(es) the web server should listen on.

Allowed WAN IP Address(es)

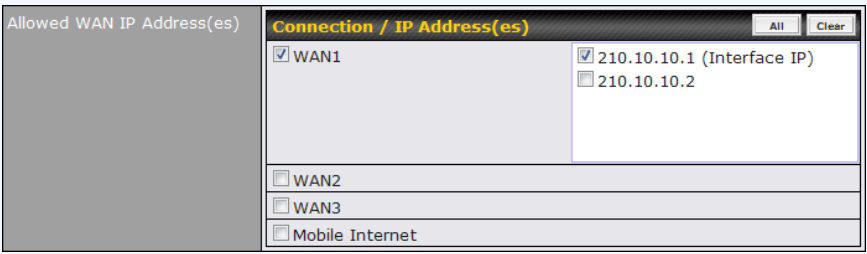

Connection / IP Address(es)	
<input checked="" type="checkbox"/> WAN1	<input checked="" type="checkbox"/> 210.10.10.1 (Interface IP) <input type="checkbox"/> 210.10.10.2
<input type="checkbox"/> WAN2	
<input type="checkbox"/> WAN3	
<input type="checkbox"/> Mobile Internet	

18.2 Firmware Upgrade

The firmware of Peplink Balance is upgradeable through Web Admin Interface.

Firmware upgrade functionality is located at: **System > Firmware**

Online Firmware Upgrade ?

Last Status	Current firmware version: 5.0.0 New firmware version: 5.1.3
-------------	--

Manual Firmware Upgrade ?

Firmware Image

There are two ways to upgrade the unit. The first method is online firmware upgrade. The system can check **Download and Upgrade** over the Internet. The second method is to upload a firmware file manually.

Click on the **Check again** button to use online upgrade. With online upgrade, Peplink Balance checks online for new firmware; if new firmware is available, the firmware is automatically downloaded by Peplink Balance. The upgrade process will subsequently be automatically initiated.

You may also download a firmware image from the Peplink website (<http://www.peplink.com>) and update the unit manually. Click **Browse...** to select the firmware file from the local computer, then click **Upgrade** to send the firmware to Peplink Balance. Peplink Balance will then automatically initiate the firmware upgrade process.

Firmware Upgrade Status for Peplink Balance 20, 30, 210 and 310

Status LED Information during firmware upgrade:

- OFF – Firmware upgrade in progress (DO NOT disconnect power.)
- Red – Unit is rebooting
- Green – Firmware upgrade successfully completed

Important Note

The firmware upgrade process may not necessarily preserve the previous configuration, and the behavior varies on a case-by-case basis. Consult the Release Notes for the particular firmware version.

Do not disconnect the power during firmware upgrade process.

Do not attempt to upload a non-firmware file, or a firmware file that is not qualified, or not supported, by Peplink.

Upgrading a Peplink Balance unit with an invalid firmware file will damage the unit, and may void the warranty.

18.3 Time

The Time Server functionality enables the system clock of Peplink Balance to be synchronized with a specified Time Server.

The settings for Time Server configuration are located at: **System > Time**

Time Settings	
Time Zone	(GMT-08:00) Pacific Time (US & Canada) <input type="checkbox"/> Show all
Time Server	time.nist.gov <input type="button" value="Default"/>

Time Server Settings	
Time Zone	<p>This specifies the time zone (along with the corresponding Daylight Savings Time scheme) in which Peplink Balance operates.</p> <p>The Time Zone value affects the time stamps in the Event Log of Peplink Balance and E-mail notifications.</p> <p>Checked the box Show all to show all time zone options.</p>
Time Server	<p>This setting specifies the NTP network time server to be utilized by Peplink Balance.</p>

18.4 Email Notification

The Email Notification functionality of Peplink Balance provides a System Administrator with up to date information on network status.

The settings for configuring Email Notification are found at: **System > Email Notification**

Email Notification Setup	
Email Notification	<input checked="" type="checkbox"/> Enable
SMTP Server	smtp.mycompany.com <input checked="" type="checkbox"/> Require authentication
SSL Encryption	<input type="checkbox"/> (Note: any server certificate will be accepted)
SMTP Port	25 <input type="button" value="Default"/>
SMTP User Name	smtuser
SMTP Password	*****
Confirm SMTP Password	*****
Sender's Email Address	admin@mycompany.com
Recipient's Email Address	system@mycompany.com staff@mycompany.com

Email Notification Settings	
Email Notification	<p>This setting specifies whether or not to enable Email Notification.</p> <p>If the box Enable is checked, Peplink Balance sends email messages to a System Administrator when the WAN status changes, or when new firmware is available.</p> <p>If the box Enable is not checked, Email Notification is disabled and Peplink Balance will not send email messages.</p>
SMTP Server	<p>This setting specifies the SMTP server to be used for sending email. If the Server requires authentication, check the box Require authentication.</p>
SSL Encryption	<p>Check the box to enable SMTPS. When the box is checked, the next field SMTP Port will be changed to 465 automatically.</p>
SMTP Port	<p>This field is for specifying the SMTP Port number.</p> <p>By default, this is set to 25; when the SSL Encryption box is checked, the default port number will be set to 465.</p> <p>You may customize the port number by editing this field. Click the button Default to restore to default.</p>
SMTP User Name / Password	<p>This setting specifies the SMTP username and password while sending email. These options are shown only if Require authentication check box is checked in SMTP Server setting.</p>
Confirm SMTP Password	<p>This field allows you to verify and confirm the new administrator password.</p>
Sender's Email Address	<p>This setting specifies the sender email address reported by the email messages sent by Peplink Balance.</p>
Recipient's Email Address	<p>This setting specifies the email address to which Peplink Balance should send the email messages to. You may enter multiple recipients' email addresses in this field.</p>

After you have completed the settings, you can click the **Test Email Notification** button to test the settings before saving it. After it is clicked, you will see this screen to confirm the settings:

Test Email Notification	
SMTP Server	smtp.mycompany.com
SMTP Port	25
SMTP User Name	smtpuser
Sender's Email Address	admin@mycompany.com
Recipient's Email Address	system@mycompany.com staff@mycompany.com

Click **Yes** to confirm. Wait a few seconds. You will see a returned message and the detailed test result.

Test email sent. Email notification settings are not saved, it will be saved after clicked the 'Save' button.

Test Result

```
[INFO] Try email through connection #3
[<-] 220 ESMT
[->] EHLO balance
[<-] 250-smtp Hello balance [210.210.210.210]
250-SIZE 100000000
250-8BITMIME
250-PIPELINING
250-AUTH PLAIN LOGIN
250-STARTTLS
```

18.5 Remote Syslog

The Remote Syslog functionality of Peplink Balance enables event logging at a specified remote Syslog server.

The settings for configuring Remote System Log are found at: **System > Remote Syslog**

Remote Syslog Setup	
Remote Syslog	<input type="checkbox"/> Enable
Remote Syslog Host	<input type="text"/> Port: <input type="text" value="514"/>

Save

Remote Syslog Settings	
Remote Syslog	This setting specifies whether or not to log events at the specified remote Syslog server.
Remote Syslog Host	This setting specifies the IP address or host name of the remote Syslog server.
Port	This setting specifies the port number of the remote Syslog service. By default, the Port setting value is 514 .

18.6 SNMP

SNMP, or Simple Network Management Protocol, is an open standard that can be used to collect information about the Peplink Balance unit.

SNMP configuration is located at: **System > SNMP**

SNMP Settings	
SNMP Device Name	Balance
SNMPv1	<input type="checkbox"/> Enable
SNMPv2	<input type="checkbox"/> Enable
SNMPv3	<input type="checkbox"/> Enable
<input type="button" value="Save"/>	

Community Name	Allowed Source Network	Access Mode	
MyCompany	192.168.1.20/24	Read Only	<input type="button" value="Delete"/>
<input type="button" value="Add SNMP Community"/>			

SNMPv3 User Name	Authentication / Privacy	Access Mode	
snmpuser	MD5 / DES	Read Only	<input type="button" value="Delete"/>
<input type="button" value="Add SNMP User"/>			

SNMP Settings	
SNMP Device Name	This field shows the router name defined in System > Admin Security .
SNMPv1	This option allows you to enable SNMP version 1.
SNMPv2	This option allows you to enable SNMP version 2.
SNMPv3	This option allows you to enable SNMP version 3.

To add a community for either SNMPv1 or SNMPv2, click the **Add SNMP Community** button in the **Community Name** table, upon which the following screen is displayed:

SNMP Community Setting	
Community Name	<input type="text" value="MyCompany"/>
Allowed Source Subnet Address	<input type="text" value="192.168.1.20"/>
Allowed Source Subnet Mask	<input type="text" value="255.255.255.0"/> <input type="button" value="v"/>
<input type="button" value="Save"/>	

SNMP Community Settings	
Community Name	This setting specifies the SNMP Community Name.
Allowed Source Subnet Address	This setting specifies a subnet from which access to the SNMP server is allowed. Enter subnet address here (e.g. 192.168.1.0).
Allowed Source Subnet Mask	This setting specifies the subnet mask that corresponds to the subnet specified via Allowed Source Subnet Address (e.g. 255.255.255.0).

To define a user name for SNMPv3, click **Add SNMP User** in the **SNMPv3 User Name** table, upon which the following screen is displayed:

SNMPv3 User Setting	
User Name	<input type="text" value="snmpuser"/>
Authentication Protocol	MD5 ▾
Authentication Password	<input type="text" value="mypassword"/>
Privacy Protocol	DES ▾
Privacy Password	<input type="text" value="myprivacypassword"/>

SNMPv3 User Settings	
User Name	This setting specifies a user name to be used in SNMPv3.
Authentication Protocol	<p>This setting specifies via a drop-down menu the one of the following valid authentication protocols:</p> <ul style="list-style-type: none"> • NONE • MD5 • SHA
Authentication Password	This setting specifies the authentication password, and is applicable only if the MD5 or SHA authentication protocol is selected.
Privacy Protocol	<p>This setting specifies via a drop-down menu the one of the following valid privacy protocols:</p> <ul style="list-style-type: none"> • NONE • DES
Privacy Password	This setting specifies the privacy password, and is applicable only if the DES privacy protocol is selected.

18.7 Reporting Server

The Reporting functionality enables Peplink Balance to post traffic data and other information periodically to a Peplink's Reporting Server for generating detailed historical usage reports of the device.

The settings for configuring Reporting Server functionality are found at the following location: **System > Reporting Server**:

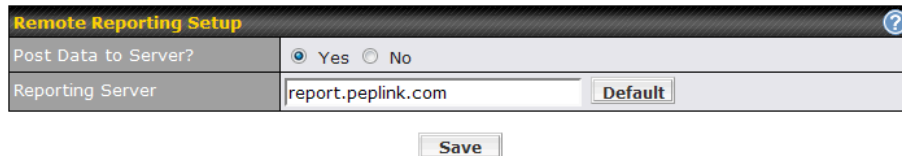

Remote Reporting Setup [?]

Post Data to Server?	<input checked="" type="radio"/> Yes <input type="radio"/> No
Reporting Server	report.peplink.com <input type="button" value="Default"/>

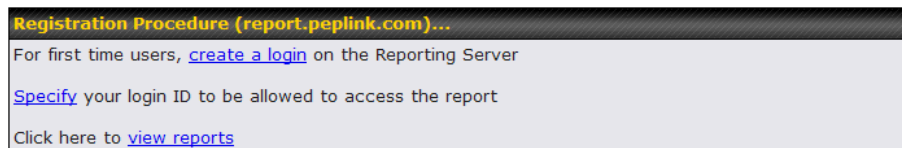

Registration Procedure (report.peplink.com)...

For first time users, [create a login](#) on the Reporting Server

[Specify](#) your login ID to be allowed to access the report

Click here to [view reports](#)

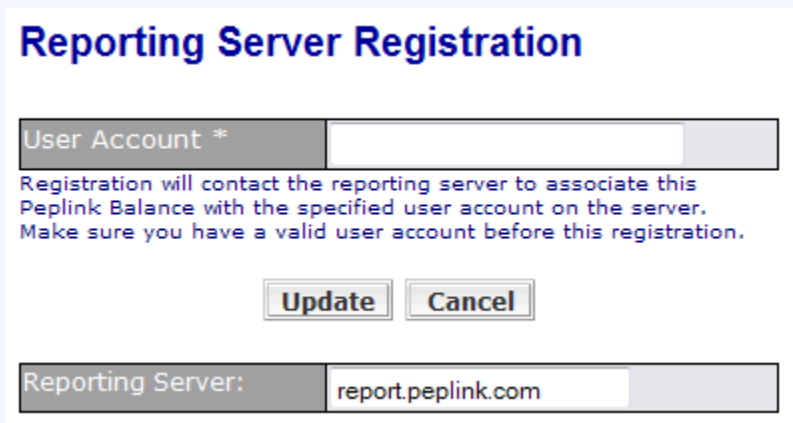
Remote Reporting Settings	
Post Data to Server	This setting specifies whether or not Peplink Balance should periodically and automatically post traffic data to reporting server.
Reporting Server	This setting specifies the Internet IP address or host name of the reporting server. By default, the Reporting Server value is report.Peplink.com.
“create a login”	Click the link to register a login ID on Peplink’s Reporting Server. Each login ID can associate with multiple Peplink Balance devices. If you already have a login ID on the server, you can skip this step.
“Specify”	<p>Click on the link and the following window will pop up:</p>  <p>The dialog box titled "Reporting Server Registration" contains a text input field for "User Account *", a "Registration will contact the reporting server to associate this Peplink Balance with the specified user account on the server. Make sure you have a valid user account before this registration." message, "Update" and "Cancel" buttons, and a "Reporting Server:" field with the value "report.peplink.com".</p> <p>Fill in the “User Account” field to specify the login ID on the Reporting Server to be allowed to access the report of this Peplink Balance device.</p>

Click the link to view link usage reports from the Reporting Server. A login screen should be shown:

“view reports”



Important Note

The registration process will establish contact to the reporting server to associate the Peplink Balance unit with the specified user account on the server.

Prior to registration, please ensure that the user account to be entered is valid.

18.8 Configuration

Backing up the Peplink Balance settings immediately after the successful completion of the initial setup is strongly recommended.

The functionality to download and upload Peplink Balance settings is found at: **System > Configuration**

The image displays four sequential screenshots of the Peplink Balance web interface, separated by horizontal lines. Each screenshot has a dark header bar with a title and a help icon (question mark in a circle) on the right.

- Restore Configuration to Factory Settings:** The header bar contains the title and help icon. Below it is a light blue bar with a single button labeled "Restore Factory Settings".
- Download Active Configurations:** The header bar contains the title and help icon. Below it is a light blue bar with a single button labeled "Download".
- Upload Configurations:** The header bar contains the title and help icon. Below it is a form with a "Configuration File" label, an empty text input field, and a "Browse..." button. At the bottom of the form is an "Upload" button.
- Upload Configurations from High Availability Pair:** The header bar contains the title and help icon. Below it is a form with a "Configuration File" label, an empty text input field, and a "Browse..." button. At the bottom of the form is an "Upload" button.

18.8.1 Restore Configuration to Factory Settings

The **Restore Factory Settings** button is to reset the configuration to the factory default settings. You have to click the **Apply Changes** button to make the settings effective.

18.8.2 Downloading Active Configurations

The **Download** button is to backup the current active settings. Click **Download** and save the configuration file.

18.8.3 Uploading Configurations

To restore or change settings based on a configuration file, click **Browse** to locate the configuration file on the local computer, and then click **Upload**.

The new settings can then be applied by clicking the **Apply Changes** button on the page header, or discard at the Main page of Web Admin Interface.

18.8.4 Uploading Configuration from High Availability Pair

(This section applies only to Peplink Balance 210, 310, 380, 390, 580, 710 and 1350.)

In a High Availability (HA) configuration, to quickly load onto the Peplink Balance unit the configuration of its HA counterpart, click the **Upload** button.

After loading the settings, configure the LAN IP address of the Peplink Balance unit to be different from the HA counterpart.

18.9 Flash Management

The Peplink Balance 210 and 310 are equipped with dual flash memory modules. The Peplink Balance 20, 30, 380, 390, 580, 710 and 1350 have single module but with two partitions. Each flash memory or partition stores one firmware image. It does not only allow improved flexibility but also facilitates more effective management of the flash contents. It is possible to upgrade the firmware on the module/partition that is not designated for booting, so that the boot flash is unaffected by firmware upgrade process or any potential power failures throughout.

Flash module management is located at: **System > Flash Management**

For Peplink Balance 210 and 310:

	Flash 1	Flash 2
Firmware Version	v5.1.3	v5.1.0
Flash Status	Bootable	Bootable
Boot from...	★	[Select this]
Next Firmware Upgrade Target	[Select this]	★

For Peplink Balance 20, 30, 380, 390, 580, 710 and 1350:

	Flash 1	Flash 2
Firmware Version	v5.1.3	v5.0.0
Boot from...	★	[Select this]

Flash Management	
Firmware Version	This displays the firmware version on each flash module/partition (i.e. Flash 1 or Flash 2)
Flash Status	This shows the status of the flash module.
Boot from...	The star indicates the flash module/partition from which Peplink Balance will perform its next boot.
Next Firmware Upgrade Target	The star indicates the flash module that is the target of the next firmware upgrade. By default, the target of the next firmware upgrade is the flash module that is NOT designated for the next boot.

For Peplink Balance 210, and 310, by clicking **Load config from Flash X**, the configuration parameters on the corresponding flash module will be loaded but not applied. (X corresponds to the flash module that is NOT designated for the next boot.) For example, clicking **Load config from Flash 1** loads the configuration from Flash 1, but does not apply the corresponding settings.

The configuration parameters are applied upon clicking the **Reboot** button at **System > Reboot**.

18.10 Reboot

This page provides a Reboot button for restarting the system.

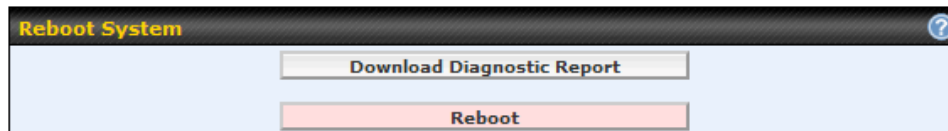

Important Note

Download Diagnostic Report button is for exporting a report file required for system investigation. If you encounter issues and would like to contact Peplink Support Team (<http://www.peplink.com/contact/>), please download this file and attach it along with a description of your encountered issue.

18.11 Ping Test

The Ping Test tool in Peplink Balance performs Pings through a specified Ethernet interface. Number of pings can be specified in **Number of times** with a maximum of 10 times.

The Ping utility is located at **System > Tools > Ping**, illustrated as follows:

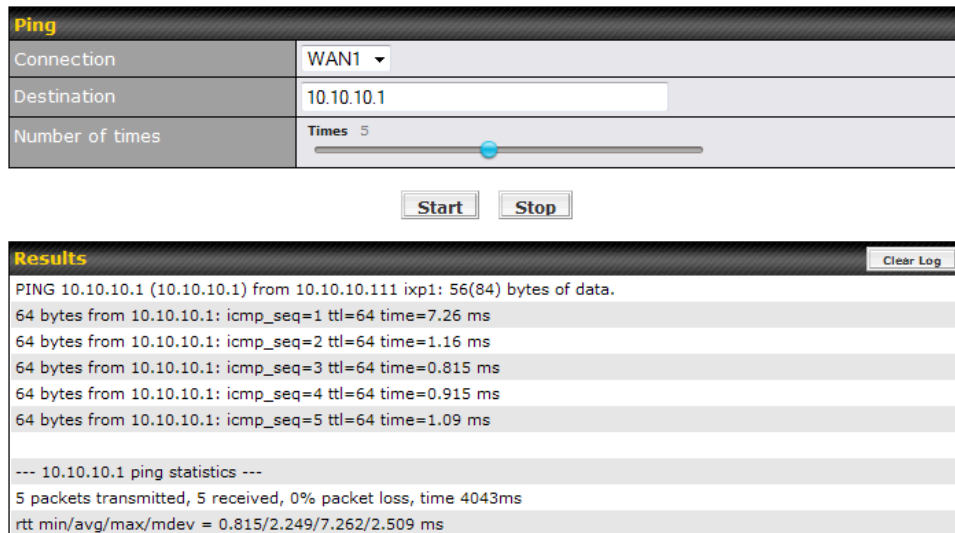

The screenshot shows the 'Ping' utility interface. It has a configuration section with the following fields:

Connection	WAN1
Destination	10.10.10.1
Number of times	Times 5

Below the configuration are 'Start' and 'Stop' buttons.

The 'Results' section shows the following output:

```
PING 10.10.10.1 (10.10.10.1) from 10.10.10.111 ixp1: 56(84) bytes of data.  
64 bytes from 10.10.10.1: icmp_seq=1 ttl=64 time=7.26 ms  
64 bytes from 10.10.10.1: icmp_seq=2 ttl=64 time=1.16 ms  
64 bytes from 10.10.10.1: icmp_seq=3 ttl=64 time=0.815 ms  
64 bytes from 10.10.10.1: icmp_seq=4 ttl=64 time=0.915 ms  
64 bytes from 10.10.10.1: icmp_seq=5 ttl=64 time=1.09 ms  
  
--- 10.10.10.1 ping statistics ---  
5 packets transmitted, 5 received, 0% packet loss, time 4043ms  
rtt min/avg/max/mdev = 0.815/2.249/7.262/2.509 ms
```

Tip

A System Administrator can use the Ping utility to manually check the connectivity of a particular LAN/WAN connection.

18.12 Traceroute Test

The Traceroute Test tool in Peplink Balance traces the routing path to the destination through a particular Ethernet interface.

The Traceroute Test utility is located at **System > Tools > Traceroute**, illustrated as follows:

Traceroute	
Connection	WAN1 ▾
Destination	64.233.189.99

Results		<input type="button" value="Clear Log"/>
traceroute to 64.233.189.99 (64.233.189.99), 30 hops max, 40 byte packets		
1	balena-0108-05-10-23-1-718.mg 1.402 mg 1.518 mg	
2	193.128.128.128 (193.128.128.128) 1.597 mg 1.570 mg 1.551 mg	
3	193.128.128.128 (193.128.128.128) 1.597 mg 1.570 mg 1.551 mg	
4	64.233.189.99 (64.233.189.99) 17.201 mg	
5	64.233.189.99 (64.233.189.99) 1.597 mg 1.570 mg 1.551 mg	
6	64.233.189.99 (64.233.189.99) 1.597 mg 1.570 mg 1.551 mg	

Tip

A System Administrator can use the Traceroute utility to analyze the connection path of a LAN/WAN connection.

19 Status

This section displays the information of Peplink Balance on the **Device**, **Active Sessions**, **Client List**, **WINS Client List**, **Site-to-Site VPN**, **UPnP / NAT-PMP**, **Event Log**, and **Bandwidth**.

19.1 Device

System information is located at **Status > Device**:

System Information	
Router Name	Balance_XXXX
Model	Peplink Balance 30
Hardware Revision	2
Serial Number	1824-XXXX-XXXX
Firmware	5.1.4 build 1018
Uptime	5 days 15 hours 35 minutes
System Time	Wed May 19 11:44:47 PDT 2010

Interface	MAC Address
LAN	10:56:AA:02:03:BB
WAN 1	10:56:AA:02:03:BC
WAN 2	10:56:AA:02:03:BD
WAN 3	10:56:AA:02:03:BE

System Information	
Router Name	This is the name specified in the field Router Name located in System > Admin Security.
Model	This shows the model name and number of this device.
Hardware Revision	This shows the hardware version of this device.
Serial Number	This shows the serial number of this device.
Firmware	This shows the firmware version in which this device is currently running.
Uptime	This shows the length of time since the device is rebooted.
System Time	This shows the current system time.

The second table shows the MAC address of each LAN/WAN interface connected.

19.2 Active Sessions

Information on Active Sessions is at: **Status > Active Sessions**

Filter: 192.168.1.110					
<input type="checkbox"/> 1 WAN1	<input type="checkbox"/> 2 WAN2	<input type="checkbox"/> 3 WAN3			
<input type="checkbox"/> Mobile Internet	<input type="checkbox"/> VPN				
Outbound					
Protocol	Source IP	Destination IP	Service	Interface	Idle Time
TCP	192.168.1.110:4147	123.123.123.1:443	HTTPS	WAN1	00:00:02
ICMP	192.168.1.110	60.60.60.1		WAN1	00:00:02
TCP	192.168.1.110:2423	123.123.123.1:443	HTTP	WAN1	00:00:13
TCP	192.168.1.110:1144	123.123.123.123:5222	XMPP Client	WAN2	00:00:19
TCP	192.168.1.110:1156	65.65.65.1:1863		WAN1	00:00:22
UDP	192.168.1.110:62817	90.123.90.1:123	NTP	WAN2	00:00:29
Inbound					
Protocol	Source IP	Destination IP	Service	Interface	Idle Time
UDP	10.10.10.112:1024	192.168.1.110:514	Syslog	WAN1	00:00:20

This Active Sessions section displays the active inbound / outbound sessions of each WAN connection on Peplink Balance.

A filter is available to help sort out the active session information. Enter a keyword in the field or check one of the WAN connection boxes for filtering.

19.3 Client List

The client list table is located at **Status > Client List**. It lists DHCP client **IP address**, their **Name** (retrieved from DHCP reservation table) and **MAC address** that the Peplink Balance has offered IP addresses to since it is powered up.

If PPTP Server in section 17.2 is enabled, you may see the corresponding connection name would be listed in the field of *Name*.

LAN Client List					
IP Address ▲	Name	Download (Kbps)	Upload (Kbps)	MAC Address	
<input type="checkbox"/> 192.168.1.10		0	0	00:11:22:33:11:22	
<input type="checkbox"/> 192.168.1.12		0	0	00:11:22:33:11:11	
<input checked="" type="checkbox"/> 192.168.1.110	Desktop	0	0	00:11:22:33:44:aa	
<input checked="" type="checkbox"/> 192.168.1.150	Site-to-Site VPN	0	0	00:11:22:33:ab:ab	

Scale: Kbps Mbps

19.4 WINS Client

The WINS client list table is located at **Status > WINS Client**. It lists WINS client IP addresses and their Names. This option will only be available when you have enabled the WINS Server in section 8. Name of clients retrieved will be automatically matched into Client List in the previous section.

Click the button **Flush All** to flush all WINS client records.

WINS Client List	
Name ▲	IP Address
UserA	10.9.2.1
UserB	10.9.30.1
UserC	10.9.2.4

Flush All



19.5 Site-to-Site VPN

(This section applies only to Peplink Balance 210 or above)

This is a page showing the current status of Site-to-Site VPN, located at: **Status > Site-to-Site VPN**

Details about Site-to-Site VPN connection peers would be shown as below.







You can simply click on the corresponding peer name to explore the WAN connection(s) status and subnet information of each VPN peer.

Site-to-Site VPN	
Peer	Remote Networks
▼ NewYork_SanFrancisco	192.168.8.0/24
WAN1	 In Use
WAN2	 In Use
▼ NewYork_Houston	192.168.99.0/24
WAN1	 In Use
▶ NewYork_Minneapolis	172.16.1.0/24 172.16.3.0/24 172.16.10.0/24 192.168.3.0/24
▶ NewYork_Seattle	172.16.123.0/24 192.168.96.0/24

19.6 UPnP / NAT-PMP

The table that shows the forwarded ports under UPnP and NAT-PMP protocols is located at **Status > UPnP / NAT-PMP**:

This section appears only if you have enabled the function of UPnP / NAT-PMP as mentioned in Section 13.4.

Forwarded Ports						
External	Internal	Internal Address	Type	Protocol	Description	
47453	3392	192.168.1.100	UPnP	UDP	Application 031	
35892	11265	192.168.1.50	NAT-PMP	TCP	NAT-PMP 58	
4500	3560	192.168.1.20	UPnP	TCP	Application 013	
5921	236	192.168.1.30	UPnP	TCP	Application 047	
22409	8943	192.168.1.70	NAT-PMP	UDP	NAT-PMP 97	
2388	27549	192.168.1.40	UPnP	TCP	Application 004	

Click the button  to delete the single UPnP / NAT-PMP record in its corresponding row. To delete all records, click **Delete All** on the right-hand side below the table.

Important Note

UPnP / NAT-PMP records would be deleted immediately after clicking the button  or **Delete All** without the need to click **Save** or **Confirm**.

19.7 Event Log

Event Log information is located at: **Status > Event Log**

Event Log		Show [50 100 all]	<input type="button" value="Refresh"/>	<input type="button" value="Clear Log"/>
Jul 15 13:56:08	WAN: WAN2 Connected			
Jul 15 13:56:17	VPN Site-to-Site: Peplink Balance 710 Connected			
Jul 15 13:56:31	WAN: WAN1 Connected			
Jul 15 13:56:31	System: Changes Applied			
Jul 15 13:56:31	WAN: WAN1 Disconnected (Health Check Failed)			
Jul 15 13:56:31	WAN2 Disconnected (Manual)			
Jul 15 13:56:31	VPN Site-to-Site: Pepwave MAX			
Jul 15 16:06:30	System: Changes Applied			

The log section displays a list of events that has taken place on the Peplink Balance unit. Click the **Refresh** button to retrieve log entries again. Click the **Clear Log** button to clear the log. Select **50**, **100**, or **all** to show the corresponding number of events in the log.

19.8 Bandwidth

This section shows the bandwidth usage statistics, located at: **Status > Bandwidth**.

Bandwidth usage will not be shown at the time when the Peplink Balance had been switched OFF.

19.8.1 Real-Time

Click **Add Trip Counter** to set a new trip counter with the current time as starting time. Click **Reset Trip Counter** to reset the starting time of this trip counter.

Data transferred since last reboot			[Add Trip Counter]
	Download	Upload	
WAN1	331 MBytes	103 MBytes	
WAN2	0 MBytes	0 MBytes	

Data transferred since last reboot			[Add Trip Counter]
	Download	Upload	
WAN1	4 821 MBytes	300 MBytes	

Data transferred since Wed Jan 06 15:40:12 HKT 2010			[Reset Trip Counter]
	Download	Upload	
WAN1	156 MBytes	4 MBytes	

Current Transfer Rate			[Add Trip Counter]
	Download	Upload	
Aggregated Transfer	35.7 Mbps	0.6 Mbps	

Current Transfer Rate			[Add Trip Counter]
WAN1	Download	Upload	
Overall	36 600 Kbps	637 Kbps	
HTTP	0 Kbps	0 Kbps	
HTTPS	0 Kbps	0 Kbps	
IMAP	0 Kbps	0 Kbps	
POP3	0 Kbps	0 Kbps	
SMTP	0 Kbps	0 Kbps	
Others	36 600 Kbps	637 Kbps	

19.8.2 Daily

This page shows the daily bandwidth usage for each WAN connection.

Select the connection in which you want to check its usage from the drop down menu. If you have enabled **Bandwidth Monitoring** feature as shown in section 10.3, the **Current Billing Cycle** table for that WAN connection will be displayed.

Click on a date to view the client bandwidth usage of that specific date. This feature is not available if you have selected to view the bandwidth usage of only a particular WAN connection.

Daily Usage				
Connection		All WAN		
Date	Download	Upload	Total	Current Month
2010-01-18	104 MB	39 MB	143 MB	Down 8 951 MB
2010-01-17	0 MB	6 MB	6 MB	Up 985 MB
				Total 9 936 MB
Client Bandwidth Usage (2010-01-18)				
IP Address	Type	Download	Upload	Total
192.168.1.150	LAN Client	104.69 MB	33.42 MB	138.11 MB
127.0.0.1	LAN Client	0.00 MB	0.00 MB	0.00 MB
10.10.10.1	LAN Client	0.00 MB	0.00 MB	0.00 MB
192.168.20.150	LAN Client	0.00 MB	0.00 MB	0.00 MB

Scale: MB GB

All WAN Daily Bandwidth Usage

Daily Usage			
Connection		WAN2	
Date	Download	Upload	Total
2010-01-18	0 MB	3 MB	3 MB
2010-01-17	0 MB	6 MB	6 MB
2010-01-16	0 MB	4 MB	4 MB
2010-01-15	5 MB	7 MB	12 MB
2010-01-14	0 MB	1 MB	1 MB
2010-01-13	0 MB	2 MB	2 MB
2010-01-12	34 MB	6 MB	40 MB
2010-01-11	7 MB	2 MB	9 MB
2010-01-10	0 MB	0 MB	0 MB
2010-01-09	0 MB	0 MB	0 MB
2010-01-08	0 MB	0 MB	0 MB
2010-01-07	0 MB	0 MB	0 MB
2010-01-06	0 MB	0 MB	0 MB

Current Billing Cycle (2010-01-01 to now)	
Down	47 MB
Up	33 MB
Total	80 MB
Allowance	102 400 MB
Used	0%

Current Month	
Down	47 MB
Up	33 MB
Total	80 MB

Scale: MB GB

WAN2 Daily Bandwidth Usage

19.8.3 Monthly

This page shows the monthly bandwidth usage for each WAN connection.

If you have enabled **Bandwidth Monitoring** feature as shown in section 10.3, a particular connection can be chosen to check its usage and select to show the monthly usage period in **Billing Cycle** or **Calendar Month**.

Click the first two rows to view the client bandwidth usage of the most recent two months. This feature is not available if you have chosen to view the bandwidth usage of only a particular WAN connection.

Monthly Usage

Connection: All WAN

Date	Download	Upload	Total
2010-03-01 to now	72 MB	32 MB	104 MB
2010-01-01 to 2010-01-31	7 643 MB	3 115 MB	10 758 MB

Client Bandwidth Usage (2010-01-01 to now)

IP Address	Type	Download	Upload	Total
192.168.1.110	LAN Client	5 887.61 MB	386.64 MB	6 274.25 MB
192.168.1.150	LAN Client	2 730.28 MB	108.10 MB	2 838.37 MB
192.168.1.10	PPTP User	315.57 MB	45.95 MB	361.51 MB
127.0.0.1	LAN Client	0.00 MB	0.02 MB	0.02 MB
10.10.10.1	LAN Client	0.00 MB	0.01 MB	0.01 MB
192.168.1.10	LAN Client	0.00 MB	0.00 MB	0.00 MB
192.168.20.150	LAN Client	0.00 MB	0.00 MB	0.00 MB
10.10.10.151	LAN Client	0.00 MB	0.00 MB	0.00 MB

Scale: MB GB

All WAN Daily Bandwidth Usage

Monthly Usage

Connection: WAN2

Period: Billing Cycle Calendar Month

Date	Download	Upload	Total
2010-01-01 to now	47 MB	33 MB	80 MB

Scale: MB GB

WAN2 Daily Bandwidth Usage

Appendix A. Restoration of Factory Defaults

To restore the factory default settings on a Peplink Balance unit, perform the following:

For Balance 20/30/210/310:

1. Locate the reset button on the Peplink Balance unit.
2. With a paper clip, press and keep the reset button pressed for at least 10 seconds, until the unit reboots itself.

For Balance 380/390/580/710/1350:

- Use the buttons on front panel to control the LCD menu to go to **Maintenance > Factory Default**, and then choose **Yes** to confirm.

Afterwards, the factory default settings will be restored.

Important Note

All user settings will be lost after restoring the factory default settings.
Regular backup of configuration parameters is strongly recommended.

Appendix B. Routing under DHCP, Static IP, and PPPoE

The information in this appendix applies only to situations where Peplink Balance operates with to a WAN connection under DHCP, Static IP, and PPPoE.

For information that applies to GRE, please refer to:

- Section 10.1.4.1,

- **Routing under GRE via Network Address Translation (NAT)**
- Section 10.1.4.2, **Routing under GRE via IP Forwarding**

B.1 Routing via Network Address Translation (NAT)

When Peplink Balance is operating under NAT mode, the source IP addresses of outgoing IP packets are translated to the WAN IP address of Peplink Balance. Therefore, with NAT, all LAN devices share the same WAN IP address to access the Internet (i.e. the WAN IP address of Peplink Balance).

Operating Peplink Balance in NAT mode requires only one WAN (Internet) IP address. In addition, operating in NAT mode also has security advantages because LAN devices are hidden behind Peplink Balance, not directly accessible from the Internet, and, hence, less vulnerable to attacks.

The following figure shows the packet flow in NAT mode:

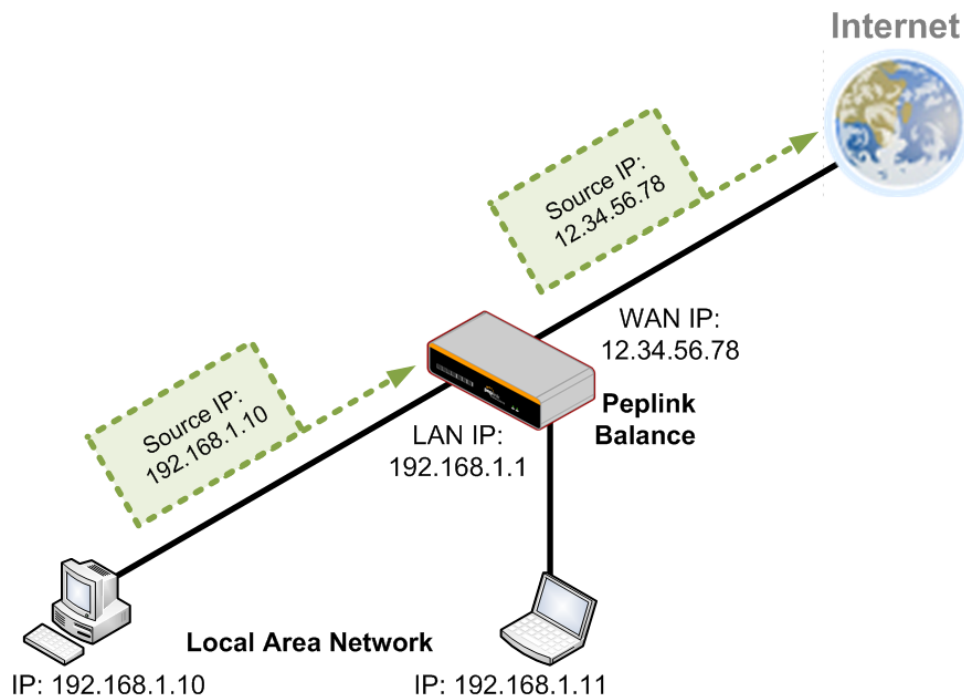

B.2 Routing via IP Forwarding

When Peplink Balance is operating under IP Forwarding mode, the IP addresses of IP packets are unchanged; Peplink Balance forwards both inbound and outbound IP packets without changing their IP addresses.

The following figure shows the packet flow in IP Forwarding mode:

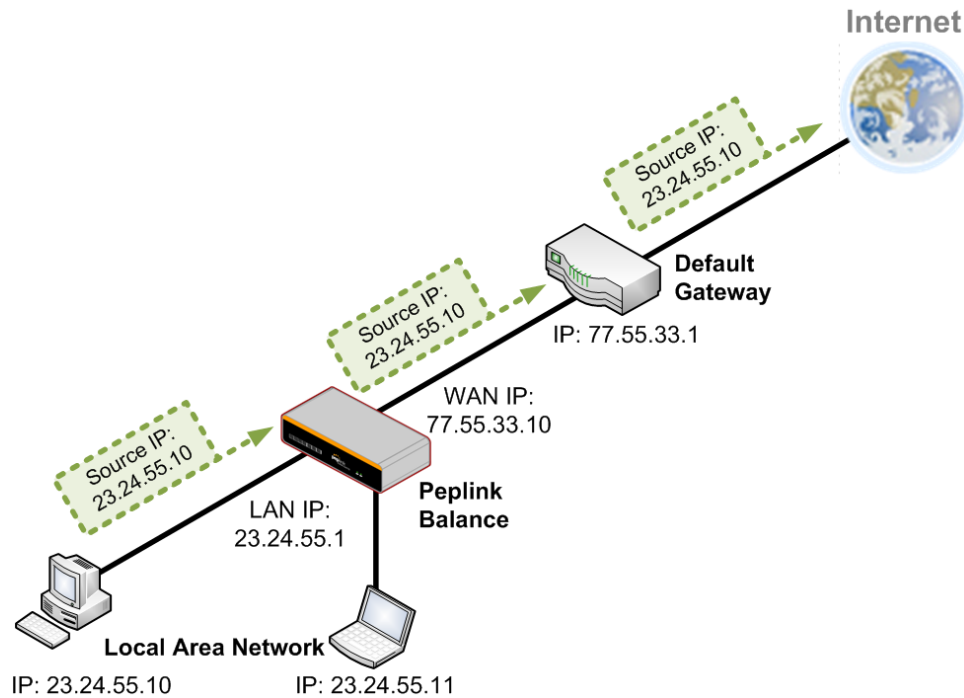

Appendix C. Case Studies

C.1 Performance Optimization

C.1.1 Scenario

In this scenario, email and web browsing are the two main Internet services used by the LAN users. The mail server is external to the network.

The connections are ADSL (with slow uplink and fast downlink) and Metro Ethernet (symmetric).

C.1.2 Solution

The solution is to individually set the WAN loading balance according to the service.

- Web browsing mainly downloads data; sending e-mails mainly consumes upload bandwidth.
- Both connections offer good download speeds; WAN2 offers good upload speeds.
- Define WAN1 and WAN2's inbound and outbound bandwidths to be 3M/512k and 4M/4M respectively.
- For HTTP, set the weight to 3 : 4.
- For SMTP, set the weight to 1 : 8, such that users will have a greater chance to be routed via WAN2 when sending e-mail.

C.1.3 Settings

1. Add a new outbound traffic rule for HTTP.
2. Add a new outbound traffic rule for SMTP.

In general, to add a new outbound traffic rule:

Click here and Select **Managed by Custom Rules**

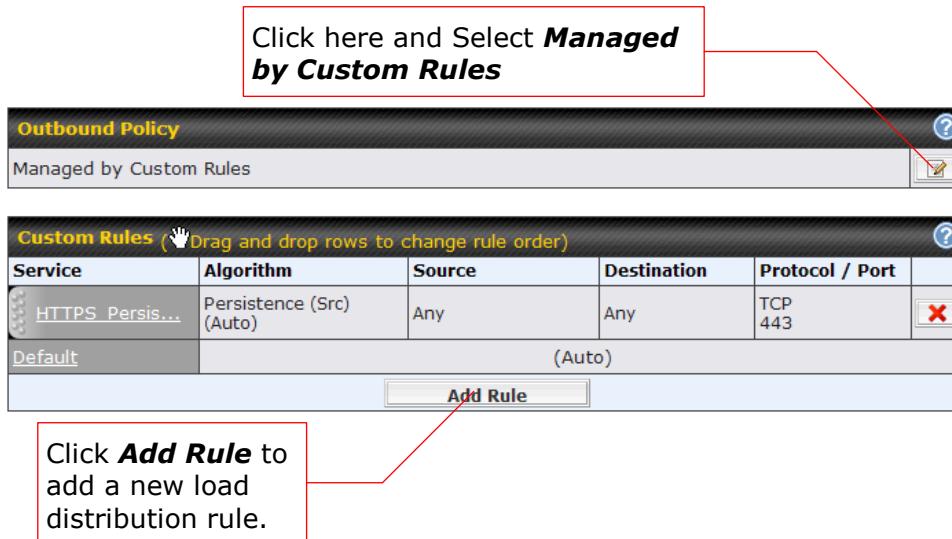

Click **Add Rule** to add a new load distribution rule.

Service	Algorithm	Source	Destination	Protocol / Port	
HTTPS Persis...	Persistence (Src) (Auto)	Any	Any	TCP 443	X
Default			(Auto)		

Settings for HTTP:

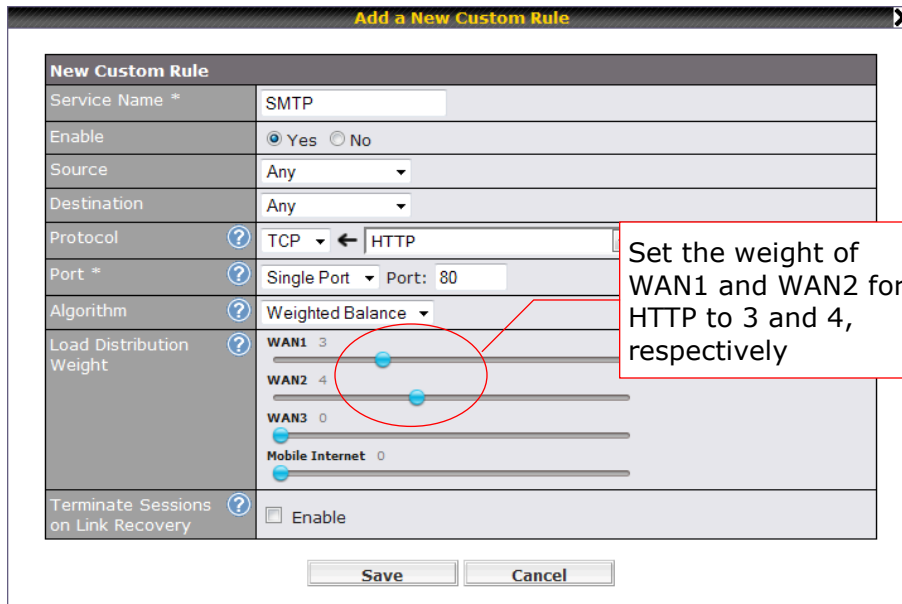

Add a New Custom Rule

New Custom Rule

Service Name *	SMTP
Enable	<input checked="" type="radio"/> Yes <input type="radio"/> No
Source	Any
Destination	Any
Protocol	TCP HTTP
Port *	Single Port Port: 80
Algorithm	Weighted Balance
Load Distribution Weight	WAN1: 3 WAN2: 4 WAN3: 0 Mobile Internet: 0
Terminate Sessions on Link Recovery	<input type="checkbox"/> Enable

Save Cancel

Settings for SMTP:

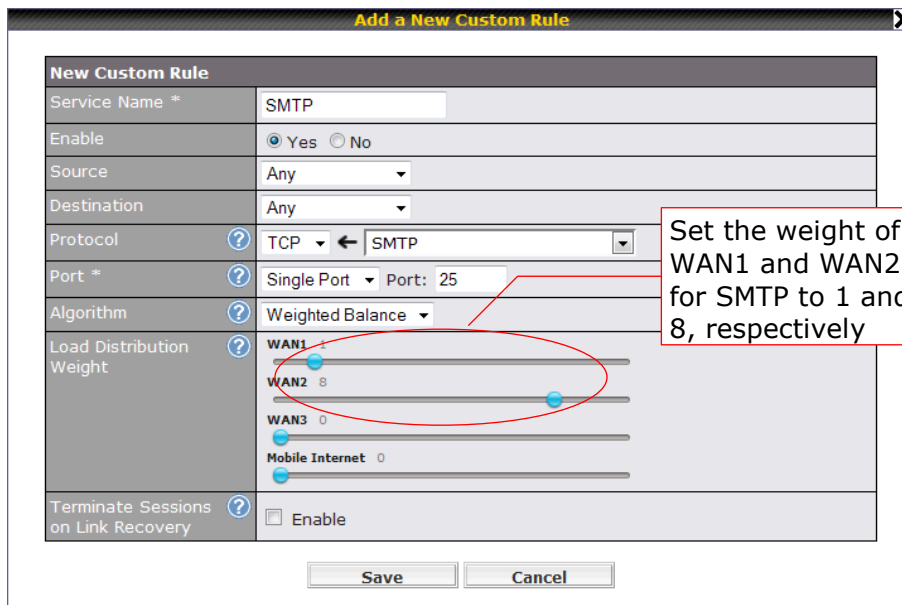

Add a New Custom Rule

New Custom Rule

Service Name *	SMTP
Enable	<input checked="" type="radio"/> Yes <input type="radio"/> No
Source	Any
Destination	Any
Protocol	TCP SMTP
Port *	Single Port Port: 25
Algorithm	Weighted Balance
Load Distribution Weight	WAN1: 1 WAN2: 8 WAN3: 0 Mobile Internet: 0
Terminate Sessions on Link Recovery	<input type="checkbox"/> Enable

Save Cancel

C.2 Maintaining the Same IP Address throughout a Session

C.2.1 Scenario

Some client IP address sensitive web sites (for example, Internet banking) use both client IP address and cookies matching for session identification. Since different IP addresses are used during the load balancing, the session is dropped when a mismatching IP is detected.

C.2.2 Solution

Make use of the Persistency functionality of Peplink Balance.

With Persistence is configured and the option **By Destination** is selected, Peplink Balance uses a consistent WAN connection for source-destination pairs of IP addresses, and prevents sessions from being dropped.

With Persistence is configured and the option **By Source** is selected, Peplink Balance uses a consistent WAN connection for same source IP addresses. This option offers even higher application compatibility but the outbound traffic load will be distributed more evenly only if more users use the Internet.

C.2.3 Settings

Set persistence in:

Network > Outbound Policy > Managed by Custom Rules

Click **Add Rule**, select **HTTP** (TCP port 80) for web service, and select **Persistence**.

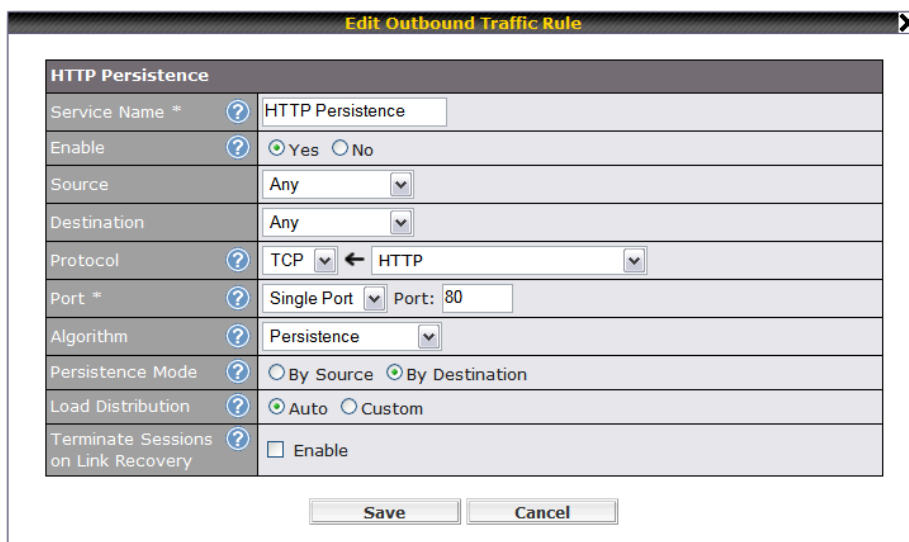

The screenshot shows a dialog box titled "Edit Outbound Traffic Rule" with a close button (X) in the top right corner. The dialog contains a table of settings for "HTTP Persistence".

HTTP Persistence	
Service Name *	HTTP Persistence
Enable	<input checked="" type="radio"/> Yes <input type="radio"/> No
Source	Any
Destination	Any
Protocol	TCP ← HTTP
Port *	Single Port Port: 80
Algorithm	Persistence
Persistence Mode	<input type="radio"/> By Source <input checked="" type="radio"/> By Destination
Load Distribution	<input checked="" type="radio"/> Auto <input type="radio"/> Custom
Terminate Sessions on Link Recovery	<input type="checkbox"/> Enable

At the bottom of the dialog are "Save" and "Cancel" buttons.

Tip

A network administrator can use the **Traceroute** utility to manually analyze the connection path of a particular WAN connection.

C.3 Bypassing the Firewall to Access Hosts on LAN

C.3.1 Scenario

There are times when remote access to computers on the LAN is desirable; for example, when hosting web sites, online businesses and FTP download and upload areas, etc.

In such cases, it may be appropriate to create an inbound NAT mapping for the network to allow some hosts on the LAN to be accessible from outside of the firewall.

C.3.2 Solution

Web Admin Interface can be used for adding an inbound NAT mapping to a host and to bind the host to the WAN connections, via **Network > NAT Mappings > Add NAT Rule**

For example, the following settings add the host, with IP address 192.168.1.102, to an Inbound Mapping and bind the host to the default IP and 211.123.123.100 of WAN1:

LAN Host	<input type="text" value="192.168.1.102"/>										
Inbound Mappings	<table border="1"><thead><tr><th colspan="2">Connection / Inbound IP Address(es)</th></tr></thead><tbody><tr><td><input checked="" type="checkbox"/> WAN1</td><td><input checked="" type="checkbox"/> 211.123.123.100 (Interface IP) <input type="checkbox"/> 211.123.123.101</td></tr><tr><td><input type="checkbox"/> WAN2</td><td></td></tr><tr><td><input type="checkbox"/> WAN3</td><td></td></tr><tr><td><input type="checkbox"/> Mobile Internet</td><td></td></tr></tbody></table>	Connection / Inbound IP Address(es)		<input checked="" type="checkbox"/> WAN1	<input checked="" type="checkbox"/> 211.123.123.100 (Interface IP) <input type="checkbox"/> 211.123.123.101	<input type="checkbox"/> WAN2		<input type="checkbox"/> WAN3		<input type="checkbox"/> Mobile Internet	
Connection / Inbound IP Address(es)											
<input checked="" type="checkbox"/> WAN1	<input checked="" type="checkbox"/> 211.123.123.100 (Interface IP) <input type="checkbox"/> 211.123.123.101										
<input type="checkbox"/> WAN2											
<input type="checkbox"/> WAN3											
<input type="checkbox"/> Mobile Internet											
Outbound Mappings	<table border="1"><thead><tr><th colspan="2">Connection / Outbound IP Address</th></tr></thead><tbody><tr><td>WAN1</td><td>10.10.10.172 (Interface IP) ▼</td></tr><tr><td>WAN2</td><td>Interface IP ▼</td></tr><tr><td>WAN3</td><td>Interface IP ▼</td></tr><tr><td>Mobile Internet</td><td>Interface IP ▼</td></tr></tbody></table>	Connection / Outbound IP Address		WAN1	10.10.10.172 (Interface IP) ▼	WAN2	Interface IP ▼	WAN3	Interface IP ▼	Mobile Internet	Interface IP ▼
Connection / Outbound IP Address											
WAN1	10.10.10.172 (Interface IP) ▼										
WAN2	Interface IP ▼										
WAN3	Interface IP ▼										
Mobile Internet	Interface IP ▼										

C.4 Inbound Access Restriction

C.4.1 Scenario

A firewall is required in order to protect the network from potential hacker attacks and other Internet security threats.

C.4.2 Solution

Firewall functionality is built into Peplink Balance. By default, inbound access is unrestricted.

Enabling a basic level of protection involves setting up firewall rules.

For example, to set up a firewall rule between the Internet and the private network that monitors Web access from Internet, click the **Add Rule** button in the **Inbound Firewall Rules** table, and then change the settings according to the following screenshot:

New Firewall Rule	
Rule Name *	Web accesses
Enable	<input checked="" type="radio"/> Yes <input type="radio"/> No
Protocol	TCP ← HTTP
Source IP & Port	Any Address Any Port
Destination IP & Port	Any Address Single Port Port: 80
Action	<input checked="" type="radio"/> Allow <input type="radio"/> Deny
Event Logging	<input type="checkbox"/> Enable

Save Cancel

After the fields have been entered as in the screenshot, click **Save** to add the rule.

Then change the default inbound rule to **Deny** by clicking the **default** rule in the **Inbound Firewall Rules** table.

C.5 Outbound Access Restriction

C.5.1 Scenario

For security reasons, it may be appropriate to disallow LAN users to use ftp to transfer files to and from the Internet, or otherwise restrict outbound access.

This can easily be achieved by setting up an outbound firewall rule with Peplink Balance.

C.5.2 Solution

To set up a firewall between Internet and private network for outbound access, click the **Add Rule** button in the **Outbound Firewall Rules** table, and then make the settings according the following screenshot:

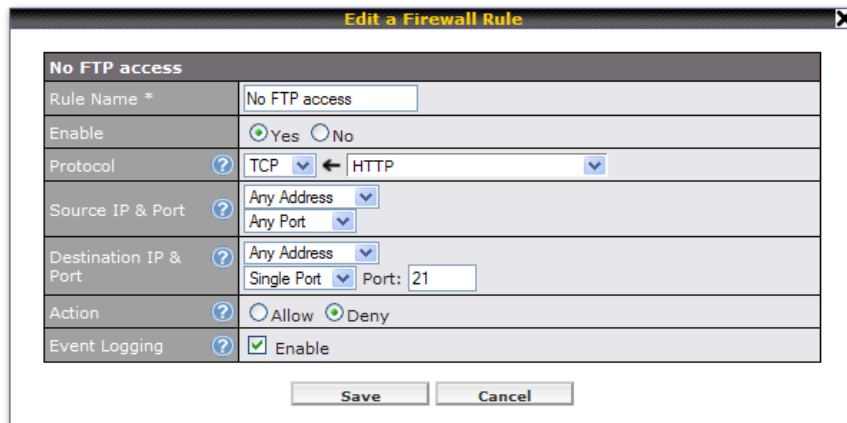

No FTP access	
Rule Name *	No FTP access
Enable	<input checked="" type="radio"/> Yes <input type="radio"/> No
Protocol	TCP ← HTTP
Source IP & Port	Any Address Any Port
Destination IP & Port	Any Address Single Port Port: 21
Action	<input type="radio"/> Allow <input checked="" type="radio"/> Deny
Event Logging	<input checked="" type="checkbox"/> Enable

Save Cancel

After the fields have been entered as in the screenshot, click **Save** to add the rule.

Appendix D. Troubleshooting

Problem 1

Outbound load is only distributed over one WAN connection.

Solution

Outbound load can only be distributed evenly to the WAN connection if many outbound connections are made. If there is only one user on the LAN and only one download session is made from his/her browser, the WAN connections cannot be fully utilized.

For a single user, download manager applications are recommended. The applications can split a file into pieces and download the pieces simultaneously. For example: FlashGet (Windows), GetRight (Windows), iGetter (MAC), etc.

If the outbound traffic is going across the Site-to-Site VPN tunnel, i.e. transferring a file to a VPN peer, all WAN connections will be bonded by our Site-to-Site VPN technology. In this case, all bandwidth will be utilized and a file will be transferred across all available WAN connections.

For details, please refer to this FAQ: <http://www.peplink.com/index.php?view=faq&id=111&path=19>

Problem 2

I am using a download manager program (e.g. FlashGet, Download Accelerator Plus, DownThemAll etc.) now. Why is the download speed still in single link's speed?

Solution

First, check whether the WAN connections are up.

Second, ensure your download manager application has split the file into 3 parts or more.

It is also possible that all of 2 or even 3 download sessions were being distributed to the same link by chance.

Problem 3

I am using some websites to lookup my public IP address, e.g. www.whatismyip.com. When I keep pressing the browser's Refresh button, the server almost always returns the same address. The IP address supposed to be changing for every refresh

Solution

The web server has enabled the **Keep Alive** function such that you were using the same TCP session to query the server.

Try to test with a web site that does not enable **Keep Alive**.

For example, try <http://private.dnsstuff.com/tools/aboutyou.ch> (This third-party web site is provided only for reference. Peplink has no association with the site and does not guarantee the site's validity or availability.)

Problem 4

What can I do if I suspect a problem on my LAN connection?

Solution

You can test the LAN connection using **Ping**.

For example, if you are using DOS/Windows, at the Command Prompt, type:

```
ping 192.168.1.1
```

This pings the Peplink Balance device (provided that Peplink Balance device's IP is 192.168.1.1) to test whether the connection to Peplink Balance is OK.

Problem 5

What can I do if I suspect a problem on my Internet/WAN connection?

Solution

You can test the WAN connection by **Ping**, which is similar to problem 4.

As we want to isolate the problems from the LAN, **Ping** will be performed from Peplink Balance. By using the **Ping/Traceroute** under the tab **Status** of the Peplink Balance, you may be able to find out the source of the problem.

Problem 6

When I upload files to a server via ftp, the transfer stalls after a few kilobytes of data are sent. What should I do?

Solution

The Maximum Transmission Unit (MTU) or MSS setting may need to be adjusted.

By default, the MTU is set at 1440. Choose **Auto** for all of your WAN connections. If it does not solve, you may try the MTU 1492 if a connection is a DSL. If the problem still persists, change the size to smaller values until your problem is resolved (e.g. 1462, 1440, 1420, 1400, etc).

Appendix E. Product Specifications

E.1 Peplink Balance 20 and 30

Routing

- Flexible Custom Outbound Routing Policy

WAN Support

- DHCP, PPPoE, GRE, and Static IP
- Outbound Link Load Balance

Device Management

- Wizard & Menu Driven Web Management Interface over HTTP / HTTPS
- Remote Reporting and Management
- Configurations Upload and Download

Internet Access Sharing

- SUA (Single User Account) / Multi-to-Multi NAT
- NAT supports PAT (Port Address Translation)

Security

- Compatible with IPsec and PPTP VPN Passthrough
- Rules-based Stateful Firewall, with IP, Protocol, and Port filtering
- Intrusion Detection System

Physical Interface

- Two (Balance 20) / Three (Balance 30) RJ-45 for an IEEE 802.3u 10/100M WAN
- Four RJ-45 for an IEEE 802.3u 10/100M LAN

Power Specification

- AV Input 100-240V, DC Output 12V

Operating Environment

- Kensington Lock Interface
- Temperature: 0°C - 50°C
- Humidity: 10% - 90% (non-condensing)

E.2 Peplink Balance 210 and 310

Routing

- Drop-in Mode and NAT
- Flexible Custom Outbound Routing Policy

WAN Support

- DHCP, PPPoE, GRE, and Static IP
- Inbound and Outbound Link Load Balance

Device Management

- Wizard & Menu Driven Web Management Interface over HTTP / HTTPS
- Remote Reporting and Management
- Bandwidth Usage Monitor
- Configurations Upload and Download

Internet Access Sharing

- SUA (Single User Account) / Multi-to-Multi NAT
- NAT supports PAT (Port Address Translation)

Security

- PPTP VPN Server
- Rules-based Stateful Firewall, with IP, Protocol, and Port filtering
- VPN Encryption: 256-bit AES
- Intrusion Detection System

Physical Interface (Balance 210)

- Two RJ-45 for an IEEE 802.3u 10/100M WAN
- Four RJ-45 for an IEEE 802.3u 10/100M LAN
- RS-232 Console / Serial (modem / TA) Port

Physical Interface (Balance 310)

- Three RJ-45 for an IEEE 802.3u 10/100M WAN
- Four RJ-45 for an IEEE 802.3u 10/100M LAN
- RS-232 Console / Serial (modem / TA) Port

Power Specification

- AV Input 100-240V, DC Output 9-30V

Operating Environment

- Temperature: 0°C - 50°C
- Humidity: 10% - 90% (non-condensing)

E.3 Peplink Balance 380 and 390

Routing

- Drop-in Mode and NAT
- Flexible Custom Outbound Routing Policy

WAN Support

- DHCP, PPPoE, GRE, and Static IP
- Inbound and Outbound Link Load Balance

Device Management

- Wizard & Menu Driven Web Management Interface over HTTP / HTTPS
- Remote Reporting and Management
- Bandwidth Usage Monitor
- Configurations Upload and Download

Internet Access Sharing

- SUA (Single User Account) / Multi-to-Multi NAT
- NAT supports PAT (Port Address Translation)

Security

- PPTP VPN Server
- Rules-based Stateful Firewall, with IP, Protocol, and Port filtering
- VPN Encryption: 256-bit AES
- Intrusion Detection System

Physical Interface (Balance 380)

- Three RJ-45 for an IEEE 802.3u 10/100M WAN
- One RJ-45 for an IEEE 802.3u 10/100M LAN
- RS-232 Console / Serial (modem / TA) Port

Physical Interface (Balance 390)

- Three RJ-45 for an IEEE 802.3ab 10/100M/1000M WAN
- One RJ-45 for an IEEE 802.3ab 10/100M/1000M LAN
- RS-232 Console / Serial (modem / TA) Port
- LAN Bypass from WAN1 to LAN for hardware revision 2

Power Specification

- AC input 110/220V

Operating Environment

- Temperature: 0°C - 40°C
- Humidity: 10% - 90% (non-condensing)

E.4 Peplink Balance 580

Routing

- Drop-in Mode and NAT
- Flexible Custom Outbound Routing Policy

WAN Support

- DHCP, PPPoE, GRE, and Static IP
- Inbound and Outbound Link Load Balance

Device Management

- Wizard & Menu Driven Web Management Interface over HTTP / HTTPS
- Remote Reporting and Management
- Bandwidth Usage Monitor
- Configurations Upload and Download

Internet Access Sharing

- SUA (Single User Account) / Multi-to-Multi NAT
- NAT supports PAT (Port Address Translation)

Security

- PPTP VPN Server
- Rules-based Stateful Firewall, with IP, Protocol, and Port filtering
- VPN Encryption: 256-bit AES
- Intrusion Detection System

Physical Interface

- Five RJ-45 for an IEEE 802.3ab 10/100M/1000M WAN
- One RJ-45 for an IEEE 802.3ab 10/100M/1000M LAN
- RS-232 Console / Serial (modem / TA) Port
- LAN Bypass from WAN5 to LAN

Power Specification

- AC input 110/220V

Operating Environment

- Temperature: 0°C - 40°C
- Humidity: 10% - 90% (non-condensing)

E.5 Peplink Balance 710

Routing

- Drop-in Mode and NAT
- Flexible Custom Outbound Routing Policy

WAN Support

- DHCP, PPPoE, GRE, and Static IP
- Inbound and Outbound Link Load Balance

Device Management

- Wizard & Menu Driven Web Management Interface over HTTP / HTTPS
- Remote Reporting and Management
- Bandwidth Usage Monitor
- Configurations Upload and Download

Internet Access Sharing

- SUA (Single User Account) / Multi-to-Multi NAT
- NAT supports PAT (Port Address Translation)

Security

- PPTP VPN Server
- Rules-based Stateful Firewall, with IP, Protocol, and Port filtering
- VPN Encryption: 256-bit AES
- Intrusion Detection System

Physical Interface

- Four RJ-45 for an IEEE 802.3u 10/100M WAN
- Three RJ-45 for an IEEE 802.3ab 10/100/1000M WAN
- One RJ-45 for an IEEE 802.3ab 10/100/1000M LAN
- RS-232 Console / Serial (modem / TA) Port

Power Specification

- AC input 110/220V

Operating Environment

- Temperature: 0°C - 40°C
- Humidity: 10% - 90% (non-condensing)

E.6 Peplink Balance 1350

Routing

- Drop-in Mode and NAT
- Flexible Custom Outbound Routing Policy

WAN Support

- DHCP, PPPoE, GRE, and Static IP
- Inbound and Outbound Link Load Balance

Device Management

- Wizard & Menu Driven Web Management Interface over HTTP / HTTPS
- Remote Reporting and Management
- Bandwidth Usage Monitor
- Configurations Upload and Download

Internet Access Sharing

- SUA (Single User Account) / Multi-to-Multi NAT
- NAT supports PAT (Port Address Translation)

Security

- PPTP VPN Server
- Rules-based Stateful Firewall, with IP, Protocol, and Port filtering
- VPN Encryption: 256-bit AES
- Intrusion Detection System

Physical Interface

- Thirteen RJ-45 for an IEEE 802.3ab 10/100/1000M WAN
- One RJ-45 for an IEEE 802.3ab 10/100/1000M LAN
- RS-232 Console / Serial (modem / TA) Port
- LAN Bypass from WAN1 to LAN

Power Specification

- AC input 110/220V

Operating Environment

- Temperature: 0°C - 40°C
- Humidity: 10% - 90% (non-condensing)



www.peplink.com



What are we doing at the moment?
Follow us on [Twitter!](#)
<http://twitter.com/Peplink>



Want to know more about us?
Add us on [Facebook!](#)
<http://www.facebook.com/peplink>



Difficulties when configuring the device?
Visit our [YouTube Channel!](#)
<http://www.youtube.com/PeplinkChannel>



Anything want to share with everyone?
Discuss on [Peplink Forum!](#)
<http://getsatisfaction.com/peplink>

Contact Us:

Sales

<http://www.peplink.com/contact/sales/>

Support

<http://www.peplink.com/contact/>

Business Development and Partnerships

<http://www.peplink.com/partners/channel-partner-program/>

Contact Address:

United States Office

800 West El Camino Real,
Mountain View
CA 94040
United States
Tel: +1 (650) 450 9668
Fax: +1 (866) 625 4664

Hong Kong Office

17/F, Park Building,
476 Castle Peak Road
Cheung Sha Wan
Hong Kong
Tel: +852 2990 7600
Fax: +852 3007 0588

Italy Office

Via Sismondi 50/3
20133 Milan
Italy
Tel: +39 02 8986 6852

Saudi Arabia Office

3/F, Saudi Business Center,
Jeddah,
Saudi Arabia
Tel: +39 02 8986 6852